



SEA-DOO®



Operator's Guide

Includes
Safety, Vehicle and
Maintenance Information

2005 GTI^{MC}
SERIES



WARNING

Read this guide thoroughly. It contains important safety information.

Do not remove this Operator's Guide from the vehicle.

2 1 9 0 0 0 3 6 7

This *Operator's Guide* utilizes the following symbols to emphasize particular information:

 The Safety Alert Symbol indicates a potential personal injury hazard.

 **WARNING** Indicates a potentially hazardous situation which, if not avoided, could result in serious injury or death.

CAUTION: Denotes an instruction which, if not followed, could severely damage vehicle components.

NOTE: Indicates supplementary information needed to fully complete an instruction.

WARNING

For your safety, understand and follow all the safety precautions and instructions contained in this *Operator's Guide*, the *Safety Videocassette* and the on-product labels. Failure to do so can result in SEVERE INJURY OR DEATH.

Keep this *Operator's Guide* in a waterproof bag with the vehicle at all times.

This *Operator's Guide* and the *Safety Videocassette* should remain with the vehicle at the time of sale.



Knight's Spray-Nine[†] is a trademark of Korkay System Ltd

GTX[†] is a trademark of Castrol Ltd. Used under license

The following is a non-exhaustive list of trademarks that are the property of Bombardier Recreational Products Inc. or its affiliates:

XP-S [™] Mineral Injection Oil	GTI [™]	Sea-Doo LK [™]
XP-S [™] Synthetic 2-stroke Oil	O.P.A.S. [™]	XP [®]
Sea-Doo Synthetic Grease	Rotax [™]	4-TEC [™]
DESS [™]	RFI [™]	3D [™]
Sea-Doo [®]	O.T.A.S. [™]	

FOREWORD

The Operator's Guide has been prepared to acquaint the owner/operator or passenger with this personal watercraft and its various controls, maintenance and safe riding instructions. It is indispensable for the proper use of the product, and should be kept in a waterproof bag with the watercraft at all times.

Make sure you read and understand the content of the Operator's Guide.

For any questions pertaining to the warranty and its application, consult the WARRANTY section in this guide, and/or an authorized Sea-Doo dealer.

In USA, products are distributed by BRP US Inc. In Canada, products are distributed by BRP.

The information and components/system descriptions contained in this guide are correct at the time of writing. BRP however, maintains a policy of continuous improvement of its products without imposing upon itself any obligation to install them on products previously manufactured.

Because of its ongoing commitment to product quality and innovation, BRP reserves the right at any time to discontinue or change specifications, designs, features, models or equipment without incurring obligation.

The illustrations in this document show the typical construction of the different assemblies and may not represent the full detail or exact shape of the parts. However, they represent parts that have the same or similar function.

It is understood that this guide may be translated into another language. In the event of any discrepancy, the English version shall prevail.

Specifications are given in the SI metric system with the SAE U.S. equivalent in parenthesis. Where precise accuracy is not required, some conversions are rounded off for easier use.

A Shop Manual can be obtained for complete service, maintenance and more repair information.

The use of LEFT (port) and RIGHT (starboard) indications in the text, always refers to driving position (when sitting on watercraft).

Furthermore, in the marine industry, FRONT is referred to BOW and REAR as STERN.

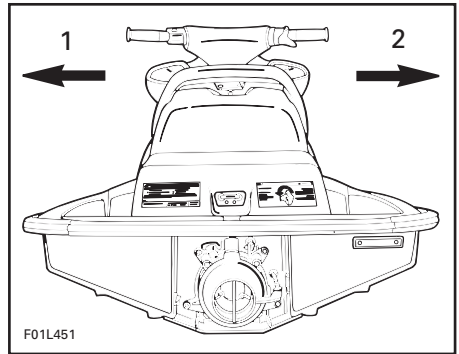

1. Left (port)
2. Right (starboard)

TABLE OF CONTENTS

SAFETY INFORMATION

INTRODUCTION	8
SAFETY CHECK LIST	9
General	9
GETTING UNDERWAY	10
To Wear	10
Helmets	12
To Bring	12
To Do	13
OPERATION	14
Collision Avoidance	14
Safe Riding	14
Operator/Passenger Awareness	14
Maneuverability of the Watercraft/Towing	15
OPERATING RULES	16
Remember these Rules of the Road	16
Navigation System	16
WATERSKIING SIGNALS	17
WEB SITES	18
LOCATION OF THE IMPORTANT LABELS	20

VEHICLE INFORMATION

REGISTRATION NUMBER LOCATION	26
IDENTIFICATION NUMBERS	27
Hull	27
Engine	27
CONTROLS/INSTRUMENTS/EQUIPMENTS	28
CONTROLS/INSTRUMENTS/EQUIPMENTS FUNCTIONS	31
1) Safety Lanyard (engine cut-off cord)	31
2) Handlebar	32
3) Throttle Lever	32
4) Engine Start/Stop Button	32
5) Choke Lever	32
6) Shift Lever	33
7) Fuel Gauge/Low Oil Warning Light (if so equipped)	33
8) Speedometer (if so equipped)	34
9) Information Center Gauge/Buttons (if so equipped)	34
10) Glove Box	36
11) Fuel Tank Valve	37
12) Fuel Tank Cap	37

13) Oil Injection Reservoir Cap	37
14) Front Storage Compartment Cover.....	38
15) Front Storage Compartment Cover Latch.....	38
16) Tool Kit.....	38
17) Air Intake Opening	38
18) Seat Strap	38
19) Seat Latch.....	38
20) Seat Extension Latch.....	39
21) Rear Grab Handle.....	39
22) Rear Storage Basket	40
23) Bow and Stern Eyelets	40
24) Mooring Cleats	40
25) Footboard	40
26) Boarding Pads	40
27) Boarding Platform	40
28) Boarding Step (if so equipped).....	41
29) Cooling System Bleed Outlet	41
30) Flushing Connector.....	41
31) Bilge Drain Plugs	42
32) Jet Pump Nozzle.....	42
33) Reverse Gate	43
34) Jet Pump Water Intake	43
35) Fuses	43
36) Battery.....	43
37) Side Vanes	43
LIQUIDS.....	45
Fueling Procedure	45
Recommended Fuel.....	45
Recommended Oil.....	46
Oil Injection System	46
BREAK-IN PERIOD.....	47
10-Hour Inspection	47
PRE-OPERATION CHECKS	48
Hull.....	49
Jet Pump Water Intake.....	49
Bilge.....	49
Water Flow in Cooling System (only when temperature is below or close to freezing point)	49
Battery	50
Fuel Tank and Oil Reservoir.....	50
Engine Compartment.....	50
Steering System	50
Throttle System	50
Shifter System	50
Storage Compartment Covers and Seat.....	51
Safety Lanyard and Engine Start/Stop Button	51

OPERATING INSTRUCTIONS	52
Principle of Operation	52
Boarding the Watercraft.....	54
Starting.....	56
Rough Water or Poor Visibility Operation	58
Crossing Waves.....	58
Stopping/Docking	58
Beaching	58
Shutting Off the Engine	59

POST-OPERATION CARE	60
General Care	60
Additional Care for Foul Water or Salt Water	60
Cooling System Flushing and Engine Internal Lubrication.....	60
Anticorrosion Treatment.....	62

SPECIAL PROCEDURES	63
Monitoring System	63
Engine Overheating.....	63
Jet Pump Water Intake and Impeller Cleaning.....	63
Capsized Watercraft	64
Submerged Watercraft.....	65
Water-Flooded Engine.....	65
Fuel-Flooded Engine.....	65
Towing the Watercraft in Water	66
Low-Charge Battery Condition	67

MAINTENANCE INFORMATION

Engine Emissions Information.....	70
General.....	71

MAINTENANCE CHART	72
Periodic Inspection	72

MAINTENANCE	75
Lubrication.....	75
Throttle and Choke Cable Inspection	76
Carburetor Adjustment.....	77
Fuel Injection System	77
Fuel and Oil Filters	77
Steering Alignment	77
Vacuum Bailer Pick-Ups	77
Fuses.....	78
O.P.A.S. System	80
General Inspection and Cleaning	80

TRAILERING, STORAGE AND PRESEASON PREPARATION	82
Trailering	82
Storage.....	83
Preseason Preparation	88

TROUBLESHOOTING	91
SPECIFICATIONS	97
INTERNATIONAL SYSTEM METRIC INFORMATION	100
ABBREVIATIONS USED IN THIS MANUAL	101

WARRANTY

BRP NORTH AMERICA LIMITED WARRANTY: 2005 SEA-DOO® GTI, GTI RFI, GTI LE RFI PERSONAL WATERCRAFT	105
CALIFORNIA EMISSION CONTROL WARRANTY STATEMENT FOR MODEL-YEAR 2005 SEA-DOO® GTI RFI, GTI LE RFI PERSONAL WATERCRAFT WITH RFI™ ENGINES.	109
BRP INTERNATIONAL LIMITED WARRANTY: 2005 SEA-DOO® GTI, GTI RFI, GTI LE RFI PERSONAL WATERCRAFT	113
PRIVACY INFORMATION.....	116
CHANGE OF ADDRESS/OWNERSHIP	117

SAFETY INFORMATION

INTRODUCTION

Congratulations, you are now the proud owner of a Sea-Doo personal watercraft. You have selected one of the most popular watercraft on water. Your Sea-Doo® personal watercraft (PWC) can provide you and your family or friends the opportunity to fully enjoy the natural beauty and excitement of the world's waterways. Welcome to fun on water!

With this new enjoyment and freedom however comes the responsibility of safety for yourself, your passengers, the people you lend your watercraft to, and other water users. Please follow all safety instructions and operate your watercraft with care. Be sure every operator of your watercraft fully understands the controls and operation of it and the importance of courteous, responsible riding. Each operator has a responsibility to ensure the safety of his/her passenger(s) and of other water users. Always inform your passengers of safety precautions.

Some of the information contained in this safety section may be new to you while other information may be common sense or obvious. Irrespective, we want you to have a safe, pleasurable riding experience, so please take a few minutes of your time to completely read this short safety section.

Failure to follow the instructions of this safety section may result in severe injury or death.

This safety section is for initial reference and its content is therefore limited. It should be read in conjunction with the rest of this Operator's Guide, the Safety Videocassette and the on-product warning/ caution labels. It is also strongly recommended that operators obtain further information concerning "Boating Rules" from a local Coast Guard Auxiliary, Powerboat Squadron or other local boating authorities.

Many states or provinces have requirements regarding boating safety and competence certificates. BRP strongly recommends that any watercraft operator completes a safety and competence boating course. Check with your local Coast Guard or Power Sail Squadron in your area for course availability.

Some boating safety information can be obtained from the Boating Safety/ Regulation Websites listed at the end of this safety section.

Regulations concerning boating are modified from time to time. It is advisable to periodically check the local regulations wherever you plan to operate your watercraft.

We encourage you to have an Annual Safety Inspection of your personal watercraft. Please contact your dealer for further details.

Finally, we urge you to visit your dealer regularly for regular and safety maintenance and for any accessories you may require.

Have fun and... Bon Voyage.

SAFETY CHECK LIST

To fully appreciate the pleasures, enjoyment and excitement of boating there are some basic rules that should be observed and followed by any boater. Failure to follow this safety information and safe boating rules could result in injury, including the possibility of death to you, your passenger(s), the people you lend your watercraft to, or other water users.

General

BRP recommends a minimum operator age of 16 years old.

A boating safety course is recommended and may be required in your province or state.

The performance of this watercraft may significantly exceed that of other craft you may have operated. Make sure to become completely familiar with the controls and operation of the watercraft before embarking on your first trip or taking on a passenger(s). If you have not had the opportunity to do so, practice driving solo in a suitable traffic free area and feel the response of each control. Be fully familiar with all controls before accelerating above idle speed. Do not assume that all PWCs handle identically. Each model differs, often substantially.

The operator of the watercraft controls, and is responsible for the watercraft's safe operation. He/she also has the responsibility to require that passenger(s) and people, to whom he/she lends the watercraft to, read and understand this safety section Operator's Guide, the Safety Video-cassette and the on-product warning/caution labels.

Ensure that all passengers know how to swim and how to reboard the watercraft from the water.

Boarding in deep water can be strenuous. Practice in chest-deep water before operating or embarking your watercraft in deep water.

A PWC will not self-right if capsized. The operator and passengers must know the proper righting procedure as explained in the Operator's Guide. Make sure engine is off before rolling over the watercraft.

Your local Power Squadron or state/provincial authorities will be pleased to conduct a complementary safety examination of your watercraft and help you define your needs.

Never ride after consuming drugs or alcohol or if you feel tired or ill.

When fueling, follow the safe boating fueling instructions explicitly, as provided in your Operator's Guide and those given to you at the marina. Always verify fuel level before use and during the ride. Apply the principle of 1/3 fuel to destination, 1/3 back and 1/3 reserve fuel supply. Do not carry spare fuel or flammable liquids in any of the storage or engine compartments.

Always stop the engine before fueling and never allow anyone to remain on the watercraft while fueling. Always remember that fuel is flammable and explosive under certain conditions. Do not smoke or allow open flames or sparks in the vicinity.

Respect no wake zones, the rights of other water users and the environment. As the "skipper" and owner of a watercraft you are responsible for damage to other crafts caused by the wake of your watercraft. Allow no one to throw refuse overboard.

Don't forget that all persons must assist other boaters in an emergency.

GETTING UNDERWAY

To Wear

The operator and passenger(s) must wear a Coast Guard approved Personal Flotation Device (PFD) that is suitable for PWC use.

An operator and the watercraft's passenger(s) should have ready access to shatterproof glasses should riding conditions or personal preference warrant. Wind, water spray and speed may cause a person's eyes to water and create blurred vision.

The operator and passenger(s) of PWCs must wear protective clothing, including:

- a wet suit bottom or thick, tightly woven, snug fitting clothing that provides equivalent protection. Thin bike shorts for example would not be appropriate. Severe internal injuries can occur if water is forced into body cavities as a result of falling into water or being near jet thrust nozzle. Normal swimwear does not adequately protect against forceful water entry into the lower body opening(s) of males or females.
- footwear, gloves and goggles/glasses are also recommended. Some type of lightweight, flexible foot protection is recommended. This will help reduce possible injury, should you step on sharp underwater objects.

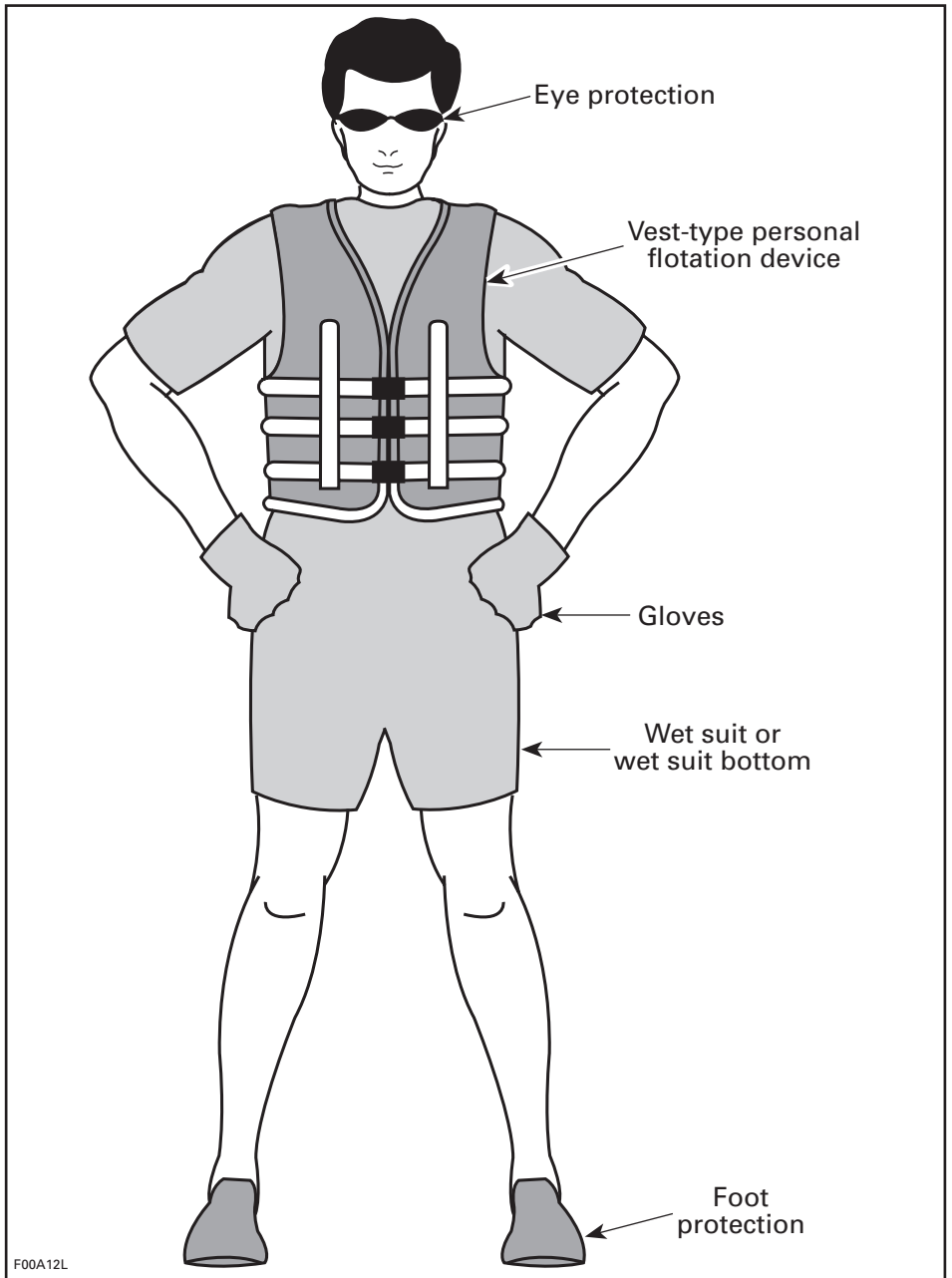

F00A12L

Helmets

Some Important Considerations

Helmets are designed to offer some degree of protection in case of impact to the head. In most motorized sports, the benefits of wearing a helmet clearly outweigh the drawbacks. However, in the case of motorized watersports such as riding personal watercraft, this is not necessarily true as there are some particular risks associated with the water.

Benefits

A helmet helps to reduce the risk of injury in case of a head impact against a hard surface such as another craft, for example, in the case of a collision. Similarly, a helmet with a chinguard might help prevent injuries to the face, jaw, or teeth.

Risks

On the other hand, in some situations when falling off the watercraft, helmets have a tendency to catch the water, like a "bucket", and put severe stresses on the neck or spine. This could result in choking, severe or permanent neck or spine injury, or death.

Helmets may also interfere with peripheral vision and hearing, or increase fatigue, which could contribute to increase the risk of a collision.

Weighing the Risks vs Benefits

In order to decide whether or not you should wear a helmet, it is best to consider the particular environment you will be riding in, as well as other factors such as personal experience. Will there be a lot of traffic on the water? What is your riding style?

The Bottom Line

Since each option minimizes some risks, but increases others, before each ride you must decide whether to wear a helmet or not based on your particular situation.

If you decide to wear a helmet, you must then decide what type is the most appropriate for the circumstances. Look for helmets that meet DOT or Snell standards, and if possible, choose one designed for motorized watersports.

Racing

Due to the nature of competition and the proximity of other crafts, BRP recommends wearing a helmet in close quarter PWC racing activities. Always follow the helmet requirements of the sanctioning organization.

To Bring

Always carry the regulatory safety items and have them conveniently on board available for use. Check the local regulations or consult your authorized Sea-Doo dealer. Such required safety items usually include, without limitation, a sound signaling device such as a whistle, a watertight flashlight or approved flares, a buoyant heaving line, an anchor and rope*, a bailer*, and an appropriate fire extinguisher*. The items marked with a "*" are not required in Canada if all persons on board a PWC are wearing a PFD.

A cellular telephone in a waterproof bag or container has also been found to be beneficial to boaters when in distress or just for contacting someone on shore.

To Do

Read and understand all warning/caution labels on your Sea-Doo PWC, your Operator's Guide, all other safety documents, and watch properly your Safety Videocassette, before operating. Always keep in mind that the "m" symbol, the Warning symbol, identifies an instruction which, if not followed, may cause serious personal injuries including the possibility of death.

Check local and federal boating laws applicable to the waterways where you intend to use your watercraft. Learn the local rules of the road. Know and understand the applicable navigation system (such as buoys and signs).

Know the waters in which the watercraft is to be operated. Current, tides, rapids, hidden obstacles, wakes and waves etc. can affect safe operation. It is not advisable to operate the watercraft in rough or inclement weather.

For safety reasons and proper care, always perform "Daily Pre-Operation Checks" as specified in your Operator's Guide before operating your watercraft.

Keep the engine shut-off cord (safety lanyard) attached to the operator's PFD at all times and keep it free from handlebars so that engine stops if operator falls off. After riding, remove cord from PWC to avoid unauthorized use by children or others. If operator falls off the watercraft and safety lanyard is unattached, the watercraft will not stop.

OPERATION

Collision Avoidance

Do not release throttle when trying to steer away from objects. You need throttle to steer.

Always keep a constant lookout for other water users, other boats or objects, especially when turning. Be alert for conditions that may limit your visibility or block your vision of others.

Respect the rights of other recreationists and/or bystanders and always keep a safe distance from all other craft, people and objects.

Do not wake or wave jump, ride the surf line or attempt to spray or splash others with your watercraft. You may misjudge the ability of the watercraft or your own riding skills and strike a boat or person.

This watercraft has the capability of turning more sharply than other boats, however, unless in an emergency, do not negotiate sharp, high speed turns. Such maneuvers make it hard for others to avoid you or understand where you are going. Also, you and/or your passenger(s) could be thrown from the watercraft.

Like any other craft, this PWC has no brake. Stopping distance will vary depending on initial speed, load, wind, and water conditions. Practice stopping and docking in a safe, traffic free area to have an idea of how long it will take to stop the watercraft under varying conditions.

Maintaining or increasing speed may be necessary to avoid a collision.

Safe Riding

Always keep in mind that as the throttle lever is released to idle position, less directional control is available, and as the engine is off, directional control is lost. You need throttle to steer.

Ride within your limits and level of riding ability. Avoid aggressive maneuvers to reduce the risk of loss of control, ejection and collision. Understand and respect the performance or your watercraft.

Always ride responsibly and safely. Use common sense and courtesy.

While your watercraft has the capacity of operating at high speeds, it is strongly recommended that high speed operation only be applied when ideal conditions exist and are permitted. Higher speed operation requires a higher degree of skill and increases the risk of severe injuries.

The forces generated on the body of riders while turning, negotiating waves or wakes, operating in choppy waters, or falling off the watercraft, especially at higher speeds, may cause injury including the possibility of broken legs and other bones or more serious injuries. Remain flexible and avoid sharp turns.

In shallow water, proceed with caution and at very low speeds. Grounding or abrupt stops may result in injury. Debris may also be picked up and be thrown rearward by the jet pump onto people or property.

Do not use the watercraft's reverse, if so equipped, to stop. You or your passenger(s) could be violently ejected forward onto the handlebars or even off the watercraft onto the hazard.

PWCs are not designed for night-time operation.

Operator/Passenger Awareness

Never turn handlebar while someone is nearby rear of watercraft. Keep away from steering moving parts (nozzle, side vanes, linkage, etc.).

Do not start or operate the watercraft if anyone is seated on the sun deck, if so equipped, or swim platform, or is nearby in the water. Water and/or debris exiting jet thrust nozzle can cause severe injury.

The operator and passenger(s) should be properly seated before starting or moving the watercraft, and at all times when watercraft is in motion. All passenger(s) should be instructed to use the handholds or seat straps provided, or in the alternative on a PWC, to hold the waist of the person in front of them.

When accelerating on a PWC with a passenger(s), whether from a complete stop or while underway, always do so progressively. Fast acceleration may cause your passenger(s) to lose their balance or grip and fall rearward off the watercraft. Make sure that your passenger(s) know of, or anticipate, any rapid acceleration.

Keep away from intake grate while engine is on. Items such as long hair, loose clothing, or PFD straps can become entangled in moving parts resulting in severe injury or drowning.

To prevent accidental starting, always detach the safety lanyard from the watercraft when swimmers are boarding or nearby, or during removal of any weeds or debris from the intake grate.

It should be remembered that sun, wind, alcohol, drugs, fatigue and illness, may impair your judgement and reaction time.

On a PWC, never place your feet and legs in the water to aid turning.

Maneuverability of the Watercraft/Towing

Do not overload the watercraft or take on more passengers than designated for the particular watercraft. Overloading can affect maneuverability, stability and performance.

Avoid adding on accessories, or equipment which may alter your control of the watercraft.

The watercraft may be fitted with tow eyelets which can be used to attach a ski rope.

Riding with a passenger(s) or pulling a tube, skier or wakeboarder makes the watercraft handle differently and requires greater skill.

Always respect the safety and comfort of your passenger(s) and person being towed on skis, wakeboard or other water products.

Always carry an observer when pulling a tube, skier or wakeboarder, proceed with only as much speed as required and follow the observer's instructions. Unless absolutely necessary, do not make tight, sharp turns. Keep a safe distance from the docks, other swimmers, craft or objects.

Use a tow rope of sufficient length and size and make sure it is adequately secured to your watercraft. While some craft are equipped or can be fitted with a specially designed towing mechanism avoid installing a tow pole on a PWC. It can become a hazard should someone fall on it.

Be advised that serious injury can result if the tow rope becomes slack during a tight turn or when circling. The rope could become wrapped around the neck or limbs of a person that has fallen in the water.

Don't forget:

Ride smart from the start and we all win!

OPERATING RULES

Operating a watercraft can be compared with driving unmarked highways and roads. To prevent collisions or avoid other boaters, a system of operating rules must be followed. It's not only common sense...it's the law!

Remember these Rules of the Road

Know the Right of Way Rules

Generally keep to your right and safely avoid other craft by keeping a safe distance from other craft, people and objects.

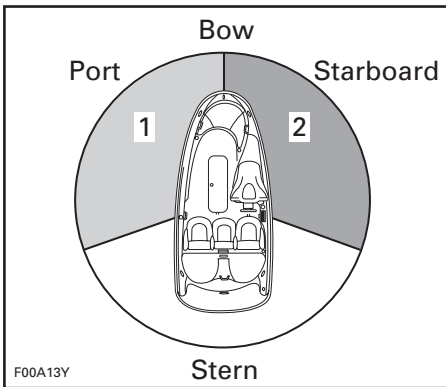

1. RED light
2. GREEN light (Yield zone)

Crossing

Give right of way to craft ahead and to your right. Never cross in front of a boat.

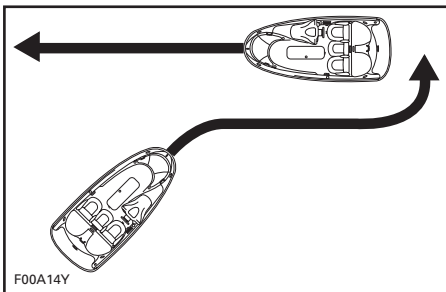

Meeting Head-On

Keep right.

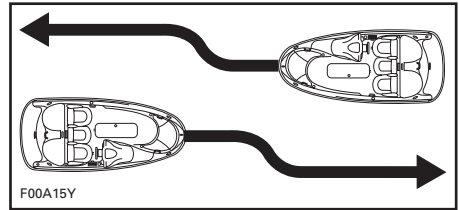

Passing

Give right of way to other craft and keep clear.

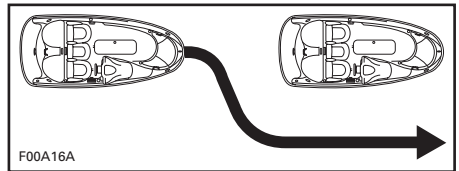

Navigation System

Navigational aids, such as signs or buoys, can assist you identify safe waters. Buoys will indicate whether you should keep to the right (starboard) or to the left (port) of the buoy or to which channel you can continue. They may also indicate whether you are entering a restricted or controlled area such as a no wake or speed zone. They may also indicate hazards or pertinent boating information. Markers maybe located on shore or on the water. They can also indicate speed limits, no power craft or boating, anchorage and other useful information. (The shape of each type of marker will provide assistance).

- Make sure you know and understand the navigation system applicable to the waterways where you intend to use the watercraft.

WATERSKIING SIGNALS

For your information, here are the most commonly used waterskiing signals.

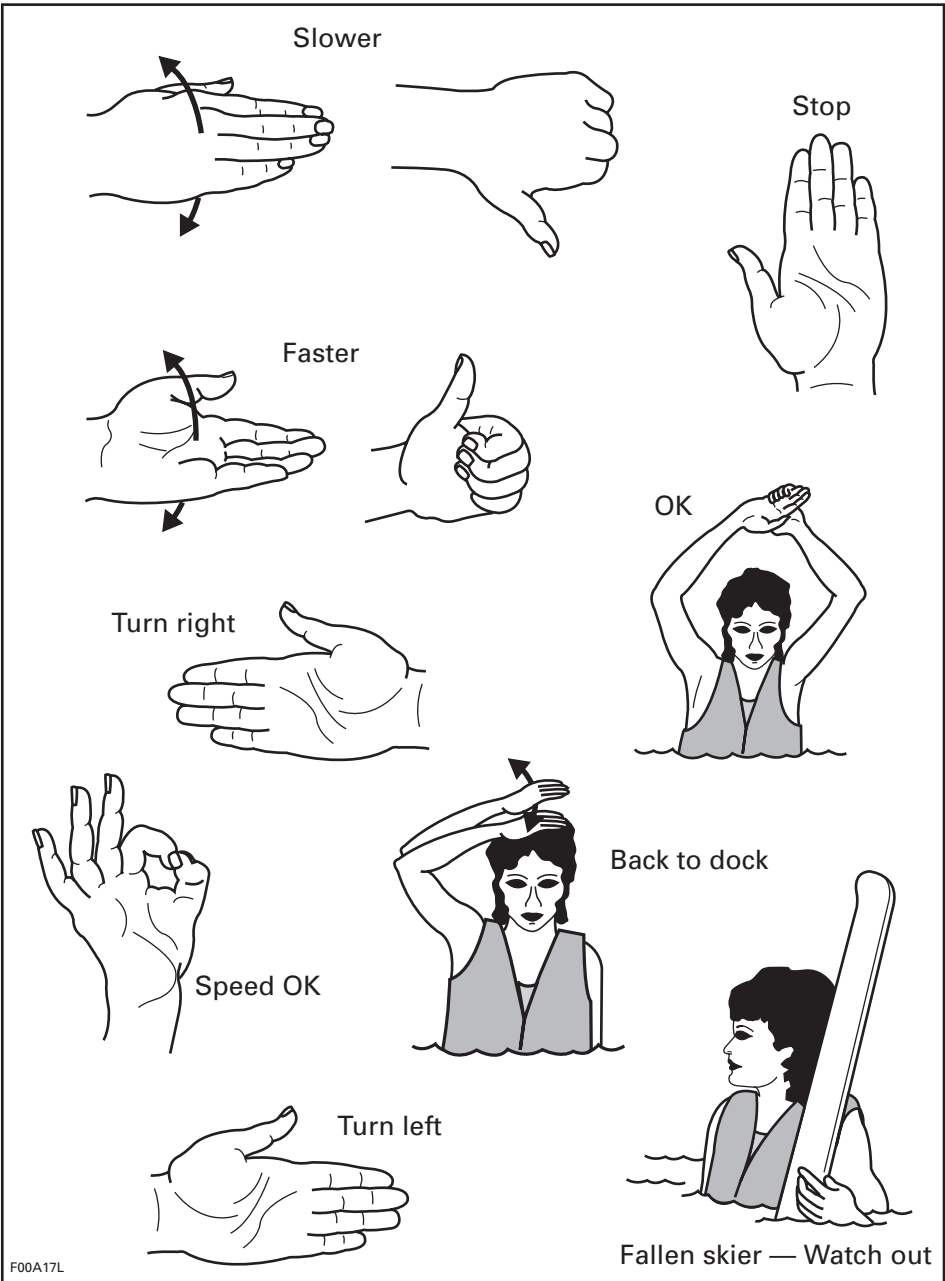

WEB SITES

Sea-Doo website: www.Sea-Doo.com

Canadian Coast Guard (Office of Boating Safety)	www.ccg-gcc.gc.ca/obs-bsn/sbg-gsn/main_e.htm
United States Coast Guard	www.uscgboating.org/regulations/boating_laws.htm
Alabama	www.dcnr.state.al.us/mp/menu.htm
Alaska	www.dnr.state.ak.us/parks/boating
Arizona	www.azgfd.com
Arkansas	www.agfc.state.ar.us/
California	www.dbw.ca.gov
Colorado	http://parks.state.co.us/boating/
Connecticut	http://dep.state.ct.us/rec/prgactiv.htm
Delaware	www.dnrec.state.de.us/fw/index.htm
Florida (freshwater)	http://floridaconservation.org/law
Florida (saltwater)	www.dep.state.fl.us/law
Georgia	www.boat-ed.com
Hawaii	www.hawaii.gov/dlnr/dbor/dbor
Idaho	www.idahoparks.org/rec/boating.html
Indiana	www.state.in.us/dnr/regulations
Iowa	www.iowadnr.com/
Kansas	www.kdwp.state.ks.us/boating/boating.html
Kentucky	www.state.ky.us/agencies/fw/boating.htm
Louisiana	www.wlf.state.la.us
Maine	www.state.me.us/ifw/rv/boatinglaws2002.htm
Maryland	www.dnr.state.md.us/boating
Massachusetts	www.state.ma.us/dfwele/dle/boatrvsafe.htm
Michigan	www.boat-ed.com/mi/handbook
Minnesota	www.dnr.state.mn.us/safety/boatwater
Mississippi	www.dmr.state.ms.us
Missouri	www.mswp.state.mo.us

Montana	www.fwp.state.mt.us/education/outdoorskills.asp
Nebraska	www.ngpc.state.ne.us/boating
Nevada	http://www.boatnevada.org/
New Hampshire	www.state.nh.us/safety/ss/links.html
New Jersey	www.state.nj.us/mvs/boats.htm
New Mexico	www.emnrd.state.nm.us/nmparks/pages/question/regulate/rules/nmac172.pdf
North Carolina	www.ncwildlife.org/fs_index_02_regulations.htm
North Dakota	http://www.state.nd.us/gnf/boating/
Ohio	www.dnr.state.oh.us/odnr/watercraft
Oregon	www.osmb.state.or.us
Pennsylvania	www.fish.state.pa.us
Rhode Island	www.state.ri.us/dem/topics/boating.htm
South Carolina	www.dnr.state.sc.us/etc/boating.html
South Dakota	www.state.sd.us/gfp/divisionwildlife/boating/index.htm
Tennessee	www.state.tn.us/twra/boatmain.html
Texas	www.tpwd.state.tx.us/boat/boat.htm
Utah	www.stateparks.utah.gov/parks/safety.htm
Virginia	www.dgif.state.va.us/boating
Washington	www.parks.wa.gov/boating.asp
West Virginia	www.dnr.state.wv.us/law/boating.htm
Wisconsin	http://www.dnr.state.wi.us/org/caer/cs/Registrations/Boats.htm
Wyoming	http://gf.state.wy.us

NOTE: State websites not listed are under development. BRP makes no representation of endorsement of any of the products or services contain within any website listed.

LOCATION OF THE IMPORTANT LABELS

The following labels are on your watercraft. If missing or damaged, they can be replaced free of charge. See an authorized Sea-Doo dealer.

Please read the following labels carefully before operating this watercraft.



TYPICAL

Label 1

 **WARNING**

To reduce the risk of **SEVERE INJURY** or **DEATH**:

WEAR A PERSONAL FLOTATION DEVICE (PFD). All riders must wear a Coast Guard approved PFD that is suitable for personal watercraft (PWC) use.

WEAR PROTECTIVE CLOTHING. Severe internal injuries can occur if water is forced into body cavities as a result of falling into water or being near jet thrust nozzle. Normal swimwear does not adequately protect against forceful water entry into lower body opening(s) of males or females. All riders must wear a wet suit bottom or clothing that provides equivalent protection (see Operator's Guide). Footwear, gloves and goggles/glasses are recommended.

KNOW BOATING LAWS. Bombardier recommends a minimum operator age of 16 years old. Know the operator age and training requirements for your province/state. A boating safety course is recommended and may be required in your province/state.

ATTACH ENGINE SHUT-OFF CORD (LANYARD) to PFD and keep it free from handlebars so that engine stops if operator falls off. After riding, remove cord from PWC to avoid unauthorized use by children or others.

RIDE WITHIN YOUR LIMITS AND AVOID AGGRESSIVE MANEUVERS to reduce the risk of loss of control, ejection and collision. This is a high performance boat - not a toy. Sharp turns or jumping wakes or waves can increase the risk of back/spinal injury (paralysis), facial injuries, and broken legs, ankles, and other bones. **Do not jump wakes or waves.**

DO NOT APPLY THROTTLE WHEN ANYONE IS AT REAR OF PWC - turn engine off or keep engine at idle. Water and/or debris exiting jet thrust nozzle can cause severe injury.

KEEP AWAY FROM INTAKE GRATE while engine is on. Items such as long hair, loose clothing, or PFD straps can become entangled in moving parts resulting in severe injury or drowning.

NEVER RIDE AFTER CONSUMING DRUGS OR ALCOHOL



PFD

Wet Suit Bottom



Jet Thrust Nozzle

Intake Grate

 **WARNING**

Collisions result in more **INJURIES AND DEATHS** than any other type of accident for personal watercraft (PWC).

TO AVOID COLLISIONS:

SCAN CONSTANTLY for people, objects, and other watercraft. Be alert for conditions that limit your visibility or block your vision of others.

OPERATE DEFENSIVELY at safe speeds and keep a safe distance away from people, objects, and other watercraft.

- Do not follow directly behind PWCs or other boats.
- Do not go near others to spray or splash them with water.
- Avoid sharp turns or other maneuvers that make it hard for others to avoid you or understand where you are going.
- Avoid areas with submerged objects or shallow water.

TAKE EARLY ACTION to avoid collisions. Remember, PWCs and other boats do not have brakes.

DO NOT RELEASE THROTTLE WHEN TRYING TO STEER away from objects - you need throttle to steer. Always check throttle and steering controls for proper operation before starting PWC.

Follow navigation rules and province/state and local laws that apply to PWCs. See Operator's Guide for more information.

Seating is limited to XX operator and XX passengers (XXX lbs./XXX kg.).

F16L0PL

Label 2

CAUTION/ ATTENTION

Use XP-S synthetic 2-stroke oil or XP-S mineral injection oil. See operator's guide.

Utiliser de l'huile synthétique 2 temps XP-S ou l'huile à injection minérale XP-S. Voir le guide du conducteur.

F00A34Y

ACCORDING TO WATERCRAFT MODEL

CAUTION/ATTENTION

Use XP-S synthetic 2-stroke oil only. See Operator's guide.

Utiliser seulement l'huile synthétique 2-temps XP-S. Voir le guide du conducteur.

F00A32Y

ACCORDING TO WATERCRAFT MODEL

Label 3

"THIS BOAT IS NOT REQUIRED TO COMPLY WITH THE FOLLOWING U.S. COAST GUARD SAFETY STANDARDS IN EFFECT ON THE DATE OF CERTIFICATION:

- FUEL SYSTEM
- SAFE LOADING
- DISPLAY OF CAPACITY INFORMATION
- FLOTATION
- POWERED VENTILATION

AS AUTHORIZED BY U.S. COAST GUARD GRANT OF EXEMPTION (CGB 88-001)."

BRP US Inc.
10101 Science Drive Sturtevant, Wisconsin 53177

MADE IN X X X

F22A0AY

E11700000

Label 4

BRP US Inc.

EMISSION CONTROL INFORMATION

This vehicle is certified to operate on unleaded gasoline and conforms to 2005 U.S. EPA & CALIFORNIA EMISSION regulations for marine SI engines.

BRP US Inc.

RENSEIGNEMENTS SUR LE DISPOSITIF ANTIPOLLUTION

Ce véhicule est certifié pour fonctionner à l'essence sans plomb et il répond aux normes 2005 de l'EPA des É.-U. & RÉGLEMENTATIONS CALIFORNIENNES pour les moteurs marins à étincelles (SI).

SEE OPERATORS GUIDE FOR MAINTENANCE SPECIFICATIONS.

VOIR MANUEL DE L'OPÉRATEUR POUR LES SPÉCIFICATIONS DE MAINTENANCE.

219902457

Engine family	XXXX	Famille de moteur
FEL	XX g/kW-hr HC+NOx	Limite des émissions de la famille
Engine displacement	XXX cc	Cylindrée
Exhaust emission control system:		Système de contrôle des Émissions
Spark plug type	NGK	Type de bougie
Spark plug gap	XX mm	Écartement des électrodes
Power	XX kw	Puissance

F22L3GL

Label 5

▲ WARNING / AVERTISSEMENT

DO NOT CHARGE OR BOOST THE BATTERY WHILE INSTALLED ON THE WATERCRAFT

219902201

NE PAS CHARGER OU SURVOLTER LA BATTERIE LORSQU'ELLE EST INSTALLÉE DANS LA MOTOMARINE

F00A23Y

Label 7

▲ WARNING / AVERTISSEMENT

- Gasoline vapors may cause fires or explosions.
- Do not overfill fuel tank.
- Keep the craft away from open flames and sparks.
- Do not start watercraft if liquid gasoline or vapors are present.
- Always replace seat (or engine cover) before starting.
- Les émanations d'essence peuvent provoquer des incendies ou des explosions.
- Éviter de trop remplir le réservoir de carburant.
- Garder la motomarine à l'écart des flammes et des étincelles.
- Ne pas démarrer la motomarine en présence d'essence liquide ou d'émanation d'essence.
- Toujours remettre le siège (ou le couvercle du compartiment-moteur) en place avant de démarrer la motomarine.

219902202

F00A27Y

Label 6

▲ WARNING / AVERTISSEMENT

- Make sure engine is off
- Grab inlet grate and step on bumper rail
- Roll boat clockwise
- S'assurer que le moteur est arrêté
- Agripper la grille d'admission et monter sur le rebord du pare-choc
- Retourner la motomarine dans le sens horaire



219902004

F00A24Y

ACCORDING TO WATERCRAFT MODEL

Label 8



F00L2YY

TYPICAL — SOME MODELS

▲ WARNING / AVERTISSEMENT

- Make sure engine is off
- Grab inlet grate and step on bumper rail
- Roll boat counterclockwise
- S'assurer que le moteur est arrêté
- Agripper la grille d'admission et monter sur le rebord du pare-choc
- Retourner la motomarine dans le sens antihoraire



219902007

F00A25Y

ACCORDING TO WATERCRAFT MODEL

Label 9

This product may be covered by one or more of the following US applications and/or patents and their non-US equivalents: Ce produit peut faire l'objet d'une ou de plusieurs demandes et/ou de brevets américains et de leurs équivalents non-américains:

20030194925A1; 20030194924A1; 20030153219A1; 20030129892A1; 20030127035A1; 20030073358A1; 20030061975A1; 20030049978A1; 20030047125A1; 20030036318A1; 20030019411A1; 20020157621A1; 20020100405A1; 20020011222A1; 20010047744A1; 6,626,140; 6,601,528; 6,595,811; 6,592,415; 6,592,413; 6,591,819; 6,568,970; 6,568,376; 6,551,155; 6,546,888; 6,544,086; 6,544,085; 6,533,623; 6,524,146; 6,523,489; 6,488,553; 6,435,119; 6,428,371; 6,419,533; 6,418,890; 6,415,759; 6,405,669; 6,390,869; 6,336,833; 6,283,099; 6,276,291; 6,174,210; 6,102,756; 6,019,648; 5,746,054; 5,603,281; 5,542,371; 5,369,360; D479,702; D465,192; D465,191; D464,928; D464,017; D464,015; D463,355; D399,182; D343,160; D326,839.

SEA-DOO, XP, RXP, GTI, LRV, 3D, LEARNING KEY, O.P.A.S., O.T.A.S., T.O.P.S., D-SEA-BEL, DESS, and their associated graphic designs are trademarks of Bombardier Recreational Products Inc. ROTAX, 4-TEC, RFI, and their associated graphic designs are trademarks of Bombardier-Rotax GmbH & Co. KG used under license. BOMBARDIER and the Bombardier Sprocket are trademarks of Bombardier Inc. used under license. GTX is a trademark of Castrol Limited used under license. ORBITAL and the ORBITAL logo are registered trademarks of Orbital Engine Company (Australia) Pty. Limited, used under license.

SEA-DOO, XP, RXP, GTI, LRV, 3D, LEARNING KEY, O.P.A.S., O.T.A.S., T.O.P.S., D-SEA-BEL, DESS, et le matériel graphique qui y correspond, sont des marques de commerce de Bombardier Produits Récréatifs inc. ROTAX, 4-TEC, RFI, et le matériel graphique qui y correspond, sont des marques de commerce de Bombardier-Rotax GmbH & Co. KG est utilisée sous licence. BOMBARDIER et le Barbotin Bombardier sont des marques de commerce de Bombardier Inc., utilisées sous licence. GTX est une marque de commerce de Castrol Limited, utilisée sous licence. ORBITAL et le logo ORBITAL sont des marques enregistrées de Orbital Engine Company (Australie) Pty. Limited, utilisées sous licence.

ACN 097 370 100

© & © 2000 -2003, Bombardier Recreational Products Inc. Bombardier Produits Récréatifs inc.

Tous droits réservés. / All rights reserved.

219 902 350

F22A09L

Label 10

Label 11

**WARNING / AVERTISSEMENT**

PRESSURIZED FUEL
Do not unscrew protective cap. Must be used only by Bombardier certified technician. Do not operate the watercraft without cap properly installed.

ESSENCE SOUS PRESSION
Ne pas dévisser le capuchon protecteur. Réservez seulement à l'usage d'un technicien certifié par Bombardier. Ne pas opérer la motomarine sans le capuchon bien installé.

F00A2QY

SOME MODELS

**WARNING / AVERTISSEMENT**

- Engine must be off when using boarding step.
- Keep away from jet and intake grate.
- Stay on center of the step.
- Only one person at a time on the step.
- Never use the step for pulling, towing, diving or jumping, boarding a PWC that is out of water or any other purpose for which it was not designed.
- Le moteur doit être arrêté lorsqu'on utilise la marche d'embarquement.
- Se tenir à l'écart de la turbine et de la grille d'admission.
- Rester au centre de la marche.
- Une personne à la fois sur la marche.
- La marche ne doit jamais servir à tirer ou à remorquer la motomarine, à plonger, à sauter à l'eau, à embarquer sur la motomarine si elle n'est pas à l'eau ou pour toute autre activité pour laquelle elle n'a pas été conçue.

F00A26Y

SOME MODELS

Label 12



SOME MODELS

VEHICLE INFORMATION

REGISTRATION NUMBER LOCATION

All personal watercraft are required by federal law to be registered and legally numbered.

Due to space availability for proper display of registration number, refer to following illustration for location. The registration number should appear on each side of the watercraft. On applicable models install registration number to the left of the star label.



TYPICAL

1. Registration number location

NOTE: The registration number must be above the water line. Ensure also that the numbers are of the correct size and color. Check with local applicable regulations.

IDENTIFICATION NUMBERS

The main components of the watercraft (engine and hull) are identified by different serial numbers. It may sometimes become necessary to locate these numbers for warranty purposes or to trace the watercraft in the event of theft.

Hull

The Hull Identification Number (H.I.N.) is located on footboard at the rear of watercraft.



F00L2EY

TYPICAL

1. Hull Identification Number

It is composed of 12 digits:

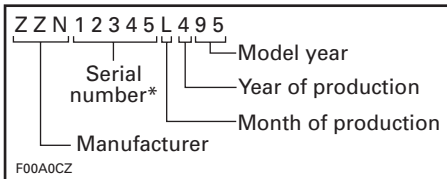

*A letter may also be used as a digit.

Engine

NOTE: Refer to SPECIFICATIONS section to find what engine is used on each model.

717 Engine

The Engine Identification Number (E.I.N.) is located on the upper side of the magneto housing.

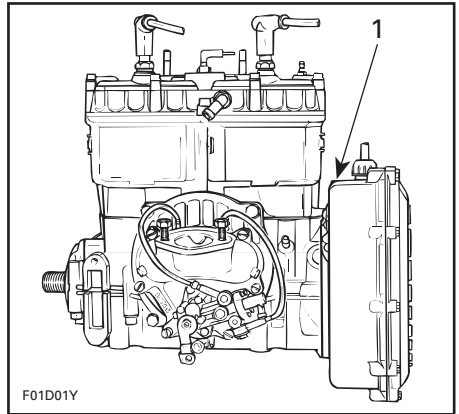

F01D01Y

TYPICAL

1. Engine Identification Number (E.I.N.)

787 RFI Engine

The Engine Identification Number (E.I.N.) is located on the upper crankcase on PTO (Power Take-Off) side.

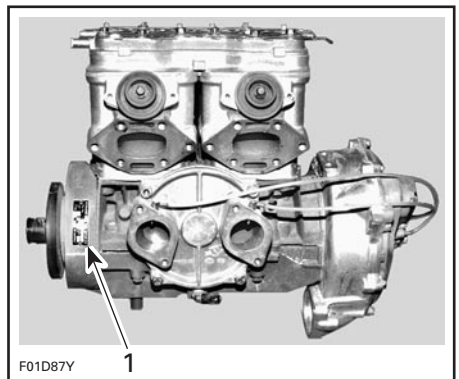

F01D87Y

1. Engine Identification Number (E.I.N.)

CONTROLS/INSTRUMENTS/EQUIPMENTS

NOTE: Some components do not apply or are optional on some models.

GTI, GTI RFI and GTI LE RFI Models

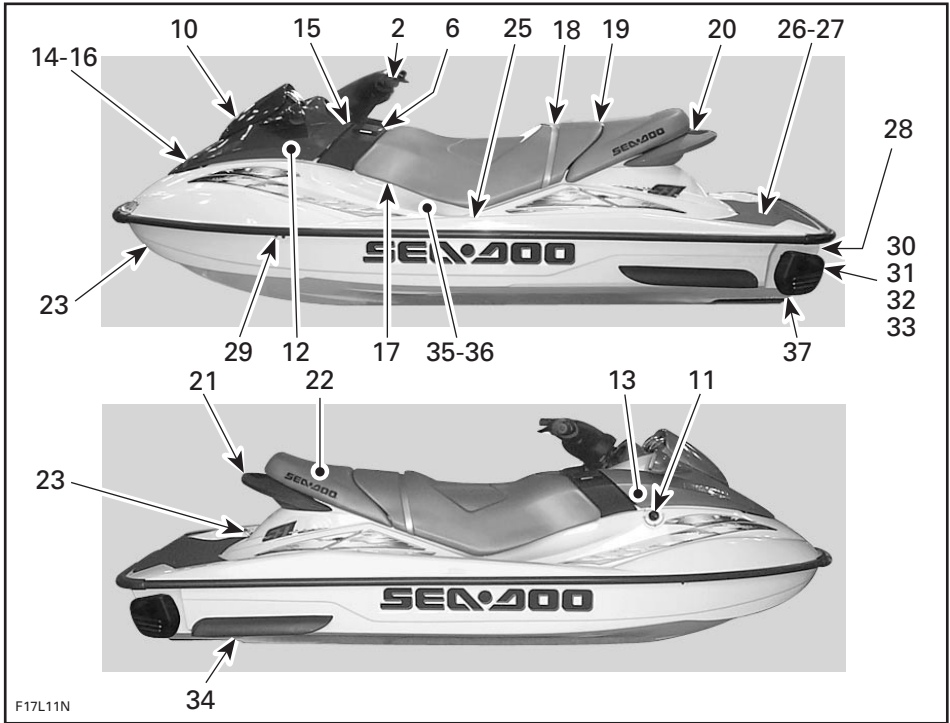

F17L11N

GTI Models

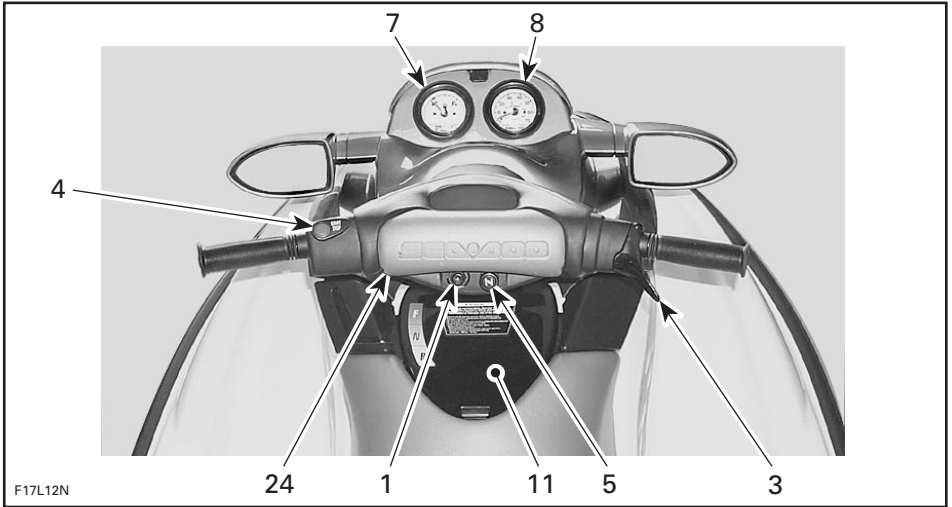

GTI RFI Models

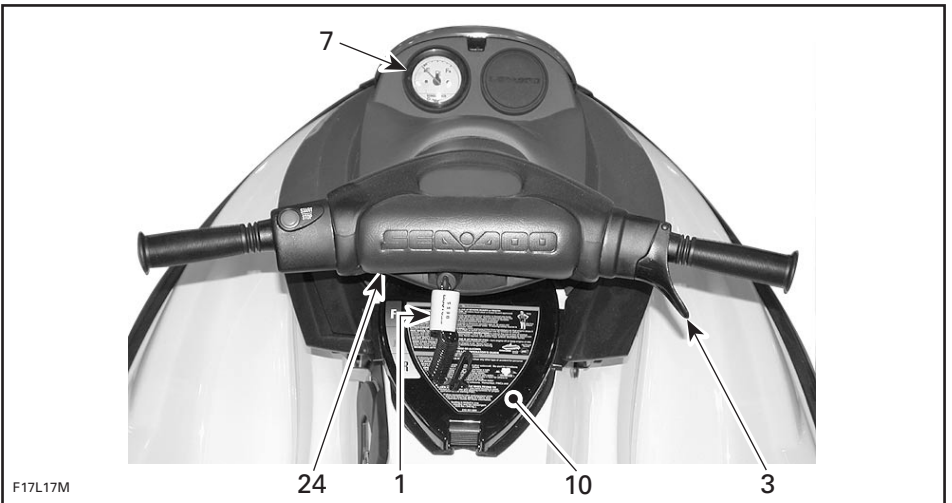

GTI LE RFI Models

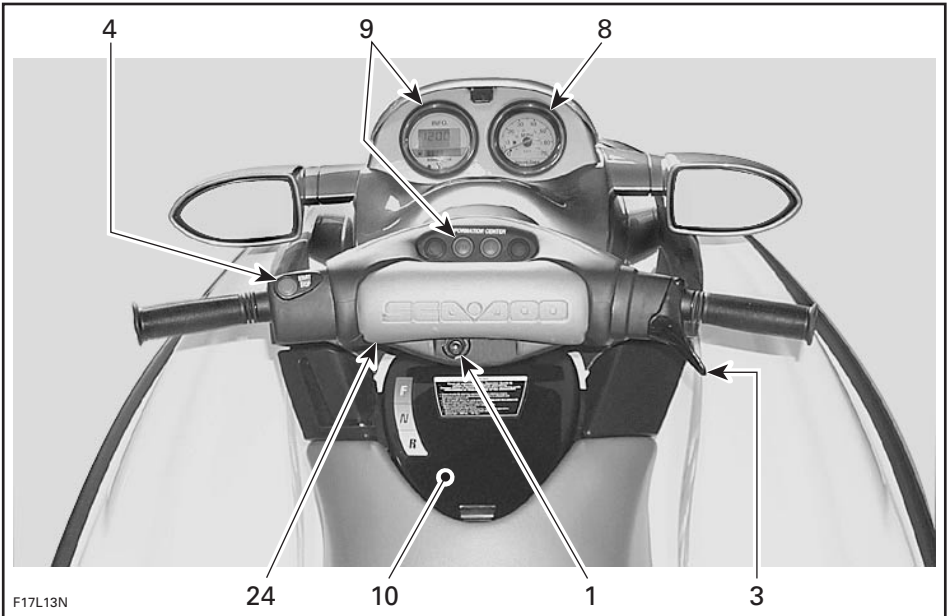

- | | |
|---|---------------------------------|
| 1. Safety Lanyard | 19. Seat Latch |
| 2. Handlebar | 20. Seat Extension Latch |
| 3. Throttle Lever | 21. Rear Grab Handle |
| 4. Engine Start/Stop Button | 22. Rear Storage Basket |
| 5. Choke Lever | 23. Bow and Stern Eyelets |
| 6. Shift Lever | 24. Mooring Cleats |
| 7. Fuel Gauge/Low Oil Warning Light | 25. Footboard |
| 8. Speedometer | 26. Boarding Pads |
| 9. Information Center Gauge/Buttons | 27. Boarding Platform |
| 10. Glove Box | 28. Boarding Step |
| 11. Fuel Tank Valve | 29. Cooling System Bleed Outlet |
| 12. Fuel Tank Cap | 30. Flushing Connector |
| 13. Oil Injection Reservoir Cap | 31. Bilge Drain Plugs |
| 14. Front Storage Compartment Cover | 32. Jet Pump Nozzle |
| 15. Front Storage Compartment Cover Latch | 33. Reverse Gate |
| 16. Tool Kit | 34. Jet Pump Water Intake |
| 17. Air Intake Opening | 35. Fuses |
| 18. Seat Strap | 36. Battery |
| | 37. Side Vanes |

CONTROLS/INSTRUMENTS/EQUIPMENTS FUNCTIONS

1) Safety Lanyard (engine cut-off cord)

The safety lanyard cap should be securely snapped onto its post to be fully operational.

Pulling the safety lanyard cap from its post stops the engine operation. Attach the safety lanyard to the operator's Personal Flotation Device (PFD) and snap the cap to the post to be able to start the engine.

WARNING

While engine can be stopped using the engine start/stop button, good habits recommend that the safety lanyard also be disconnected when stopping.

Two short beeps indicates the system is ready to allow engine starting. Otherwise, refer to the TROUBLESHOOTING section for the coded signals chart.

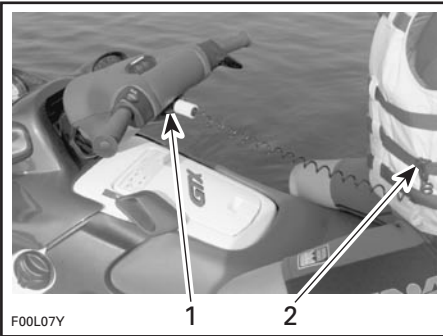

TYPICAL

1. Safety lanyard cap on the post
2. Safety lanyard secured on operator's PFD

WARNING

Should the engine be stopped, watercraft directional control is reduced. Always disconnect safety lanyard when watercraft is not in operation in order to prevent accidental engine starting or to avoid unauthorized use by children or others or theft.

If engine is not started within 5 seconds after installing the safety lanyard on its post, 4 short beeps every 3 second interval will sound for approximately 2 hours to remind you to start the engine or to remove safety lanyard. Afterwards, the beeps will stop. The same will occur when safety lanyard is left on its post 5 seconds after engine is stopped.

Always ensure safety lanyard is not left on its post after engine is stopped.

IMPORTANT: Leaving the safety lanyard on its post when engine is not running will slowly discharge the battery.

Digitally Encoded Security System (DESS)

The safety lanyard cap specifically contains an electronic circuit that gives it a unique electronic serial number. This is the equivalent of a conventional key.

This safety lanyard cannot be used on another watercraft and conversely, the one from another watercraft cannot be used on your watercraft.

However, the DESS brings a great flexibility. You can buy an additional safety lanyard and have it programmed for your watercraft.

To have additional safety lanyard, refer to an authorized Sea-Doo dealer.

WARNING

While engine can be stopped using the engine start/stop button, good habits recommend that the safety lanyard also be disconnected when stopping.

2) Handlebar

The handlebar controls the direction of the watercraft. Turning the handlebar to the right steers the watercraft to the right and inversely.

WARNING

Check handlebar and corresponding steering nozzle and side vanes operation before starting. Never turn handlebar while someone is nearby rear of watercraft. Keep away from steering moving parts (nozzle, side vanes, linkage etc.).

3) Throttle Lever

When the throttle lever is squeezed, the watercraft accelerates. When fully released, engine automatically slows down to idle speed and watercraft is gradually stopped by water drag.

Carburetor-Equipped Models

Do not depress lever unnecessarily when engine is not running. A fuel accelerator pump delivers fuel to the engine each time throttle lever is applied.

CAUTION: Engine can be flooded if throttle lever is unnecessarily applied several times. If engine is flooded, it will not start. Refer to SPECIAL PROCEDURES for instructions.

4) Engine Start/Stop Button

All Models

To start engine, depress and hold the start/stop button. Release immediately after engine is started.

To stop engine, fully release throttle lever then depress the start/stop button and disconnect safety lanyard from the post.

WARNING

Directional control is reduced when the throttle is released or when engine is off.

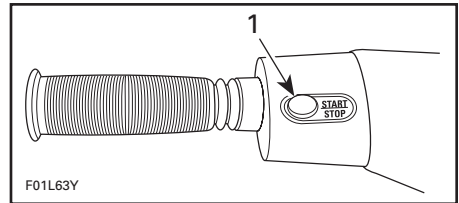

1. Engine start/stop button

5) Choke Lever

Carburetor-Equipped Models

The choke is provided to supply a richer fuel/air mixture when starting a cold engine.

Choke lever should be pulled and held to operate. Lever will automatically return to its normal position when released.

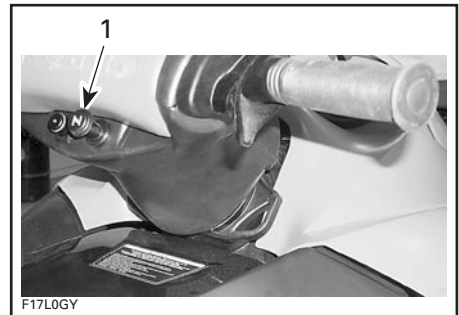

1. Choke lever

6) Shift Lever

A push-pull lever:

- forward
- neutral
- reverse.

WARNING

Shift lever should only be used when the engine is idling and watercraft is completely stopped. Do not use as a grab handle.

WARNING

Only use reverse at slow speed and for the shortest time possible. Always ensure the path behind is clear of objects and persons including children playing in shallow water.

CAUTION: Never rev the engine at high RPM in reverse.

From the forward position, pull the lever to reverse. Push back to go to forward. Always set in forward when finished. To find the neutral, set in reverse then push back until the watercraft stops moving backwards.



FORWARD POSITION



NEUTRAL POSITION



REVERSE POSITION

7) Fuel Gauge/Low Oil Warning Light (if so equipped)

Analog gauge indicates the amount of fuel in the fuel tank.

A warning light turns on when level is low in oil reservoir.

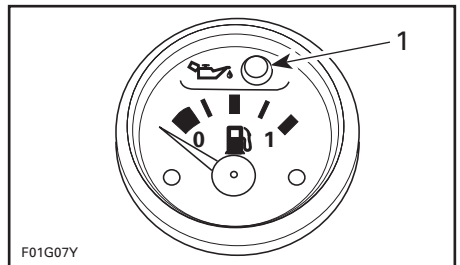

1. Low oil warning light

8) Speedometer (if so equipped)

Analog speedometer indicates the speed of watercraft in miles per hour (MPH) and kilometers per hour (km/h).

The speed sensor mounted on the ride plate sends the signal to the speedometer and information center (if so equipped).

9) Information Center Gauge/Buttons (if so equipped)

This is a LCD multifunction gauge. Different displays and functions can be activated using 2 buttons — MODE and SET — following specific sequences as described below.

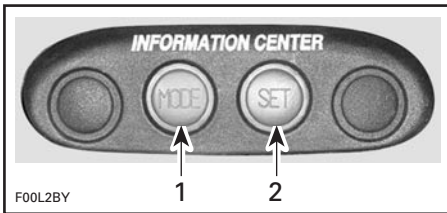

1. To change display mode
2. To set or reset a function

Resetting a Function

To reset a function (such as the chronometer, distance, etc.) press and hold the SET button for 2 seconds while in the appropriate mode.

The information center includes the following display areas.

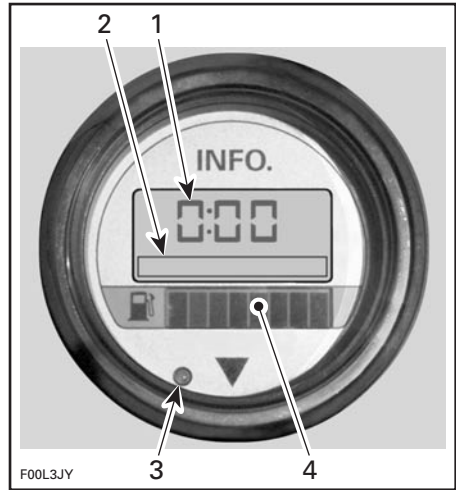

1. General display
2. Message/units display
3. Warning light
4. Fuel level display

General Display

Repeatedly pressing the MODE button scrolls the following displays: Compass (if so equipped), Tachometer, speedometer, average speed, trip meter, hourmeter, water temperature, exterior temperature (if so equipped) and chronometer.

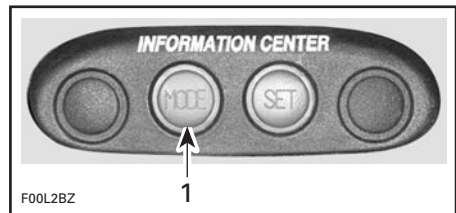

1. Press to change display mode

When you are satisfied with your choice, stop pressing the button. The display you have chosen will remain until it is changed. When safety lanyard is installed, the last chosen display will come back.

Compass (if so equipped): Displays the cardinal points to indicate the orientation of the watercraft.

WARNING

Use the compass as a guide only. Not to be used for navigation purposes.

Tachometer: Indicates the revolutions per minute (RPM) of the engine.

Speedometer: Indicates the speed of watercraft in kilometers per hour (KPH) or miles per hour (MPH).

Average Speed: The information center approximately calculates and displays the average speed (AV KPH or AV MPH) of the watercraft since the last engine start.

Trip Meter: The information center approximately calculates the distance based on the operation time and the watercraft speed and displays the result in kilometers (KM) or miles (MILES).

Hourmeter: Displays the time in hours of the watercraft usage.

Water Temperature: Displays the water temperature of the water surface (L TEMP) in degrees Celsius (°C) or Fahrenheit (°F).

Exterior Temperature (if so equipped): Displays the exterior air temperature (E TEMP) in degrees Celsius (°C) or Fahrenheit (°F).

Chronometer: Allows to measure an interval of time in hours and minutes (hh:mm).

Message Display

The information center features a display area that blinks a message whenever one of the following circumstances occurs:

- compass error (COMPAS) (if so equipped)
- maintenance (MAINT)
- engine overheating (H-TEMP)
- low fuel (FUEL-LO)
- low oil (OIL LOW)
- low voltage (12 V LOW).

A buzzer will sound when one of the four last circumstances occurs.

Except for low fuel and low oil, which can be corrected by refilling, it is recommended to see an authorized SeaDoo dealer when other messages occur.

The warning light will blink at the same time.

Warning Light

The red warning LED (Light-Emitting Diode) blinks along with the message display to catch your attention.

Fuel Level Display

Bar gauge continuously indicates the amount of fuel in the fuel tank while riding. A low-fuel condition is also indicated when it occurs. See MESSAGE DISPLAY above.

Display Priorities

As a self test, all LCD segments and the LED will turn on for 3 seconds each time the information center is activated (when safety lanyard is installed).

When the information center is activated, the last function set will be displayed if it was the tachometer, speedometer or chronometer. If another function was set, the compass will be displayed. On models without the compass function, the word "SeaDoo" will be displayed.

In the event of a warning message, the message will blink and override the units display.

If more than one warning message occurs, the blinking messages will scroll every 4 seconds.

Other Functions

The following describes how to select other available functions.

Language Option

While in the compass mode (while "SeaDoo" is displayed on models without compass):

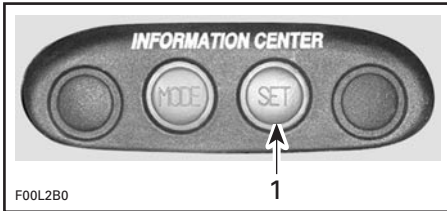

1. Press and hold for 2 seconds

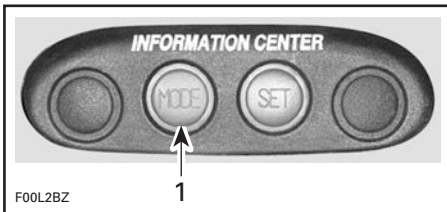

1. Repeatedly press

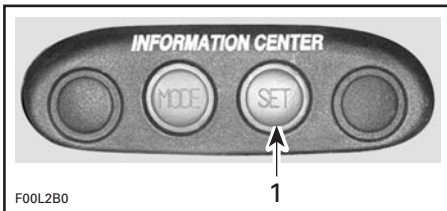

1. Press to end

English/Metric System

Allows to display the units in the metric system or in the SAE English system.

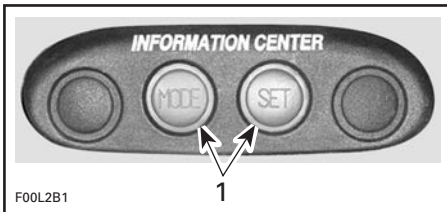

1. Press TOGETHER and hold for 2 seconds

Chronometer

While in the chronometer mode:

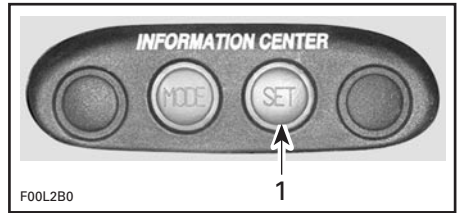

1. Press to start or stop chronometer

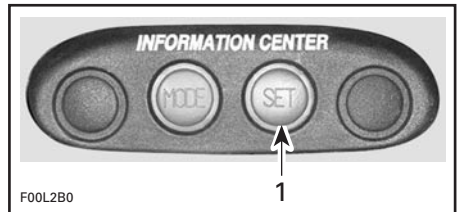

1. Press and hold for 2 seconds to reset

Chronometer is reset every time engine is turned off.

Maintenance Information

When the watercraft is due for a maintenance inspection, the message MAINT will blink.

To clear the warning message while it is blinking:

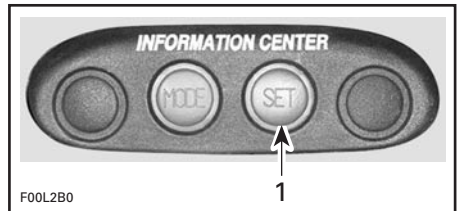

1. Press and hold for 2 seconds to reset

10) Glove Box

A small, convenient storage compartment for personal articles.

11) Fuel Tank Valve

Carburetor-Equipped Models

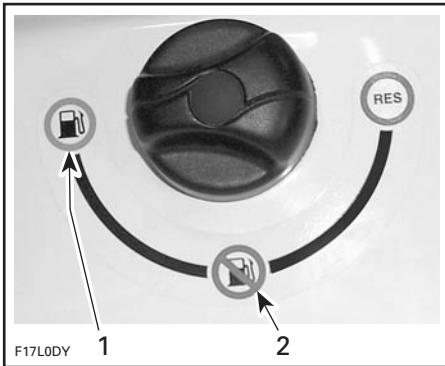

1. ON
2. OFF

A 3-position rotating valve: OFF, ON and RESERVE:

OFF: Stop fuel supply to carburetor(s).

CAUTION: Turn valve to OFF position when watercraft is not operated.

ON: Allows fuel to flow to carburetor(s). This is the normal position for operation of watercraft.

CAUTION: Improper opening of fuel valve may restrict flow of fuel and may lead to engine damage. Make sure valve is fully opened while running.

RES (RESERVE): Use when the watercraft has run out of fuel in the ON position.

Always refill the fuel tank at the first opportunity. After refueling, turn the fuel tank valve to the ON position to continue operation.

12) Fuel Tank Cap

Open the front storage compartment cover to expose fuel tank cap.

Refer to the vehicle illustration for fuel tank cap location.

Unscrew the cap counterclockwise. After fueling, reinstall cap and fully tighten.

⚠ WARNING

Always stop the engine before refueling. Fuel is flammable and explosive under certain conditions. Always work in a well ventilated area. Do not smoke or allow open flames or sparks in the vicinity. Fuel tank may be pressurized, turn cap slowly when opening. Never use an open flame to check fuel level. When fueling, keep watercraft level. Do not overfill or top off the fuel tank and leave watercraft in the sun. As temperature increases, fuel expands and might overflow. Always wipe off any fuel spillage from the watercraft. Periodically verify fuel system. Always turn the fuel tank valve (if so equipped) to OFF position when the watercraft is not in use.

13) Oil Injection Reservoir Cap

Refer to the vehicle illustration for oil injection reservoir cap location.

Open the front storage compartment cover to expose reservoir cap.

To add injection oil in the reservoir, unscrew the cap counterclockwise. Do not overfill. Reinstall cap and fully tighten it.

⚠ WARNING

Do not overfill. Reinstall cap and fully tighten. Oil is flammable. Always wipe off any oil spillage from the bilge.

Close and latch storage compartment cover.

14) Front Storage Compartment Cover

It gives access to the front storage compartment. Always relatch cover after closing.

Front Storage Compartment

A convenient watertight area to carry personal articles. Ideal location for spare spark plugs, towrope, first aid kit, etc.

WARNING

Never leave any heavy or breakable objects loose in the storage area/ basket. Never operate the watercraft with any storage compartment cover open.

If there is water in the storage area, pull out the drain plug to let water go out. Reinstall the plug when done.

NOTE: The water will flow to the bilge. If there is an important quantity of water, ensure to drain the bilge (out of water) prior to using the watercraft.



1. Drain plug

15) Front Storage Compartment Cover Latch

Pull the latch lever upward in order to open the front storage compartment cover. Always relatch.

NOTE: Verify periodically the lock pin tightness of storage cover. Tighten if needed and make sure storage cover latches properly.

16) Tool Kit

Contains tools needed to perform basic watercraft maintenance.

17) Air Intake Opening

This is where air enters to supply the engine and to ventilate the engine compartment. If the air intake opening is kept under water, water will get inside bilge.

CAUTION: If the air intake opening is kept under water, such as turning constantly in tight circles, water will get inside bilge, which may cause severe damage to internal parts of the engine.

18) Seat Strap

The seat strap provides a handhold to assist boarding and is used as a handhold for the passenger.

19) Seat Latch

Removing the seat allows access to the engine compartment.

The seat latch is located at the rear end and underneath the seat.

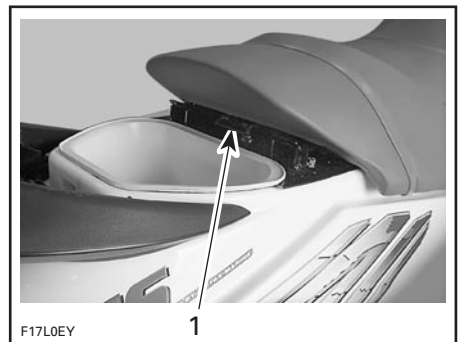

1. Seat latch

To remove the seat, pull the latch lever upward and hold. Lift and pull the seat rearward.

NOTE: It is necessary to remove the seat extension first.

When reinstalling the seat, place seat cavity over body hook.

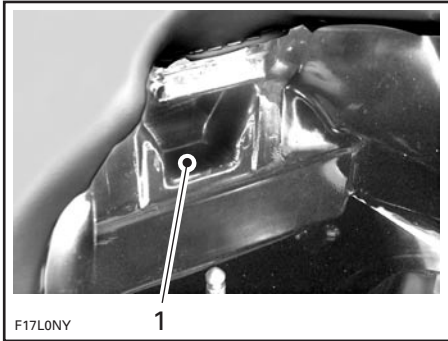

1. Seat cavity

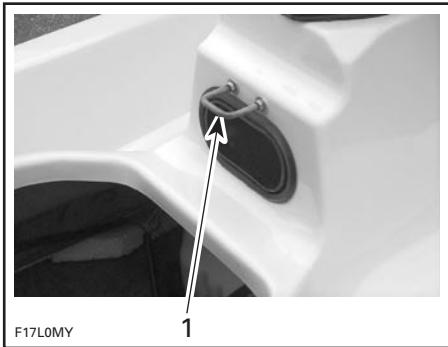

1. Body hook

To latch seat, align latch hole with pin then, firmly push downward on rear of the seat.

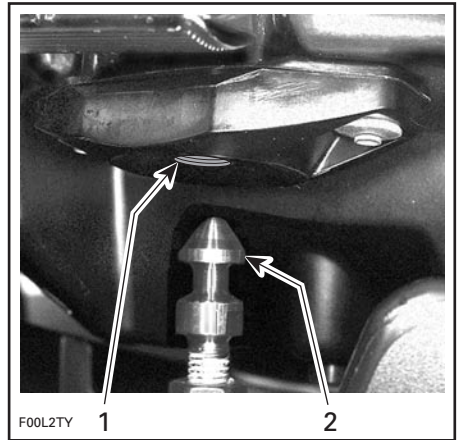

1. Latch hole
2. Pin

20) Seat Extension Latch

Removing the seat extension allows access to the rear storage basket. It also gives access to the seat latch on models with a seat extension.

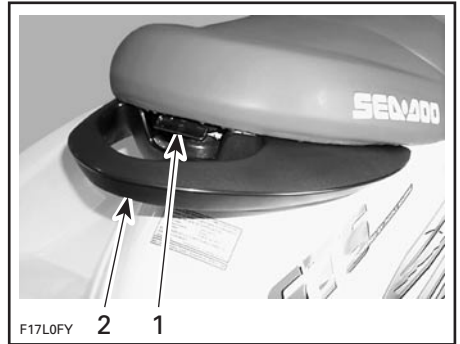

1. Seat extension latch
2. Rear grab handle

21) Rear Grab Handle

Provides a handhold for boarding when needed and a handhold for the passenger or the spotter on 3-up seat models. See illustration above.

CAUTION: Never use the grab handle to tow anything or to lift the watercraft.

22) Rear Storage Basket

A convenient watertight, removable basket to carry personal articles.

The rear storage basket includes a latch to hold an approved fire extinguisher (sold separately).



TYPICAL

23) Bow and Stern Eyelets

Bow Eyelet

Eyelets can be used for mooring, towing and as a tie-down point during trailering.

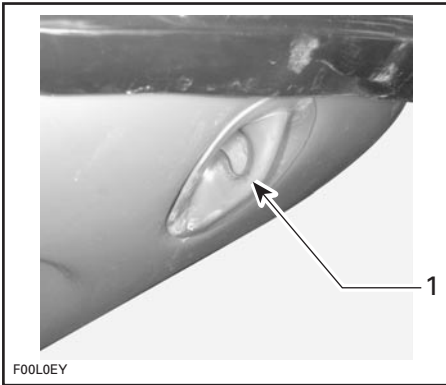

1. Bow eyelet

Stern Eyelet

This eyelet allows a rope with a hook, a closed end or an open end to be attached.

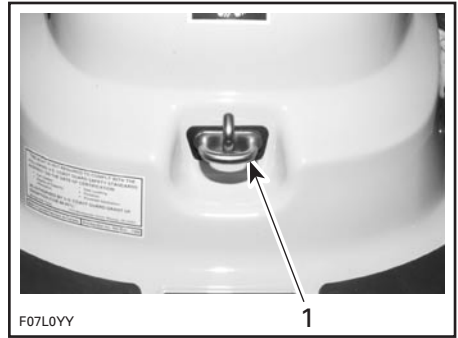

1. Stern eyelet

24) Mooring Cleats

These cleats can be temporarily used for docking, while refueling for example.

CAUTION: Never use mooring cleats to pull or lift the watercraft.

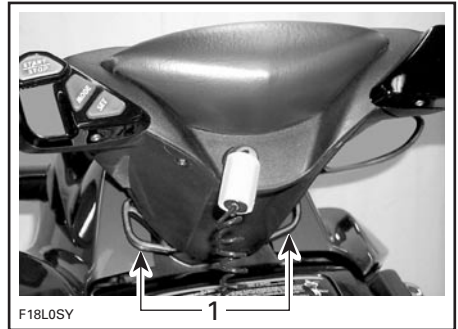

1. Mooring cleats

25) Footboard

User's feet should rest on the footboard when riding.

26) Boarding Pads

Provide a cushioned surface for the knees when boarding from rear of watercraft.

27) Boarding Platform

Provides a large surface for easier boarding from rear of watercraft.

28) Boarding Step (if so equipped)

A convenient step to help reboarding the watercraft.

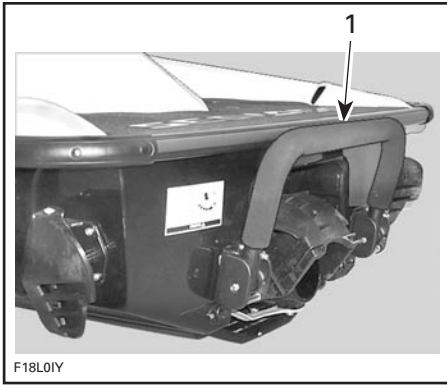

1. Boarding step

Pull down the step with your hand and hold until a foot is put on the step.

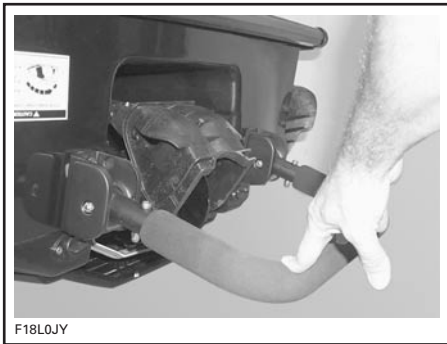

29) Cooling System Bleed Outlet



TYPICAL
1. Bleed outlet

When engine is running, water should flow from the outlet. This allows air in engine cooling system to escape. It also indicates that water is circulating in the cooling system.

NOTE: It may be required to increase slightly the engine RPM to see the water flowing out.

CAUTION: Should water not flow from outlet a few seconds after engine starts, immediately stop engine and refer to POST-OPERATION CARE and look for COOLING SYSTEM FLUSHING or refer to an authorized Sea-Doo dealer for servicing.

30) Flushing Connector

A convenient connector is provided to allow easy installation of a garden hose to flush the cooling system.

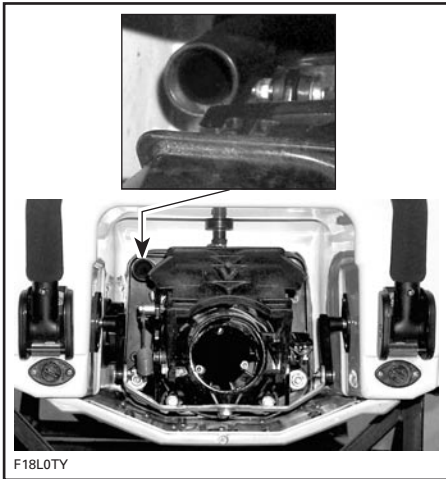

TYPICAL

Refer to POST-OPERATION CARE section for proper use.

31) Bilge Drain Plugs

Should water be found in the bilge, it can be easily drained by unscrewing the drain plugs when engine is off and watercraft is out of water.

CAUTION: Remove watercraft from water prior to unscrewing drain plugs.

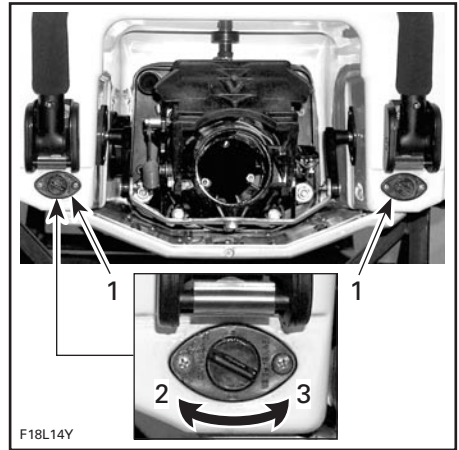

TYPICAL

1. Drain plugs
2. Tighten
3. Unscrew

Tilt the watercraft slightly to the rear so that the water can completely flow out of the bilge.

It is suggested to drain bilge on a ramp.

CAUTION: Make sure drain plugs are properly secured prior to launching the watercraft in water.

32) Jet Pump Nozzle

Jet pump nozzle turns side to side via rider input at the handlebar. This provides directional control when engine is running.

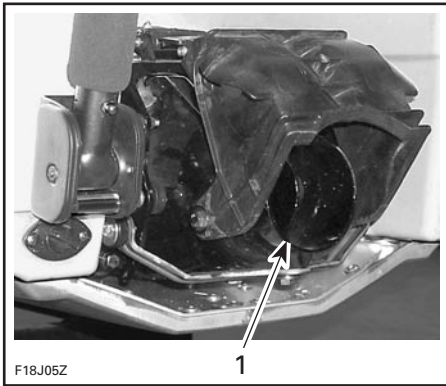

TYPICAL
1. Jet pump nozzle

33) Reverse Gate

When selecting the neutral or reverse position with the shift lever, the reverse gate moves up or down to obtain the desired position.

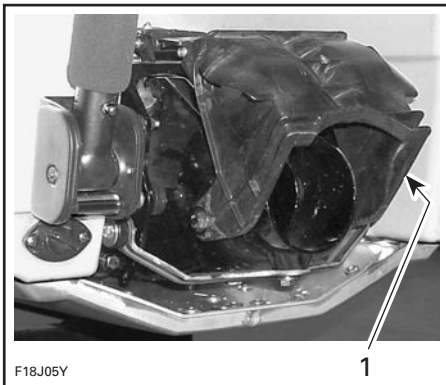

TYPICAL
1. Reverse gate

34) Jet Pump Water Intake

The water is drawn up by the impeller through this opening. The water intake grate minimizes the entry of foreign objects into the propulsion system.

⚠ WARNING

Keep away from intake grate while engine is on. Items such as long hair, loose clothing or personal flotation device straps can become entangled in moving parts resulting in severe injury or drowning.

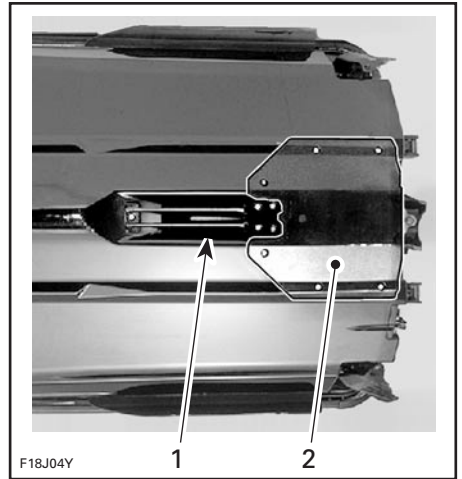

TYPICAL
1. Water intake
2. Ride plate

35) Fuses

Fuses are located under seat IN BILGE. Refer to MAINTENANCE for more details.

36) Battery

Battery is located inside engine compartment. Refer to SPECIAL PROCEDURES.

37) Side Vanes

Side vanes are part of Off-Power Assisted Steering (O.P.A.S.) system.

The side vanes assist the steering system.



WARNING

Check handlebar and corresponding side vanes operation before starting. Never use side vanes as a supporting point to board the watercraft or to lift it. Never turn handlebar while someone is nearby rear of watercraft. Keep away from steering moving parts (nozzle, side vanes, linkage etc.).

LIQUIDS

CAUTION: Scrupulously follow the instructions of this section. Failure to do so may reduce the engine's life and/or performance.

Fueling Procedure

WARNING

Follow these safe boating fueling instructions explicitly.

Turn off engine.

Do not allow anyone to remain on the watercraft.

Tie watercraft securely to the fueling pier.

Have a fire extinguisher close at hand.

Do not insert the spout too far in filler neck.

Pour fuel slowly so that air can escape from the tank and prevent fuel flow-back. Be careful not to spill fuel.

Stop filling when the fuel reaches the bottom of filler neck. Do not fill into the filler tube to prevent fuel spill out. Do not overfill. Fully tighten fuel tank cap.

WARNING

Always stop the engine before refueling. Fuel is flammable and explosive under certain conditions. Always work in a well ventilated area. Do not smoke or allow open flames or sparks in the vicinity. Fuel tank may be pressurized, turn cap slowly when opening. Never use an open flame to check fuel level. When fueling, keep watercraft level. Do not overfill or top off the fuel tank and leave watercraft in the sun. As temperature increases, fuel expands and might overflow. Always wipe off any fuel spillage from the watercraft. Periodically verify fuel system. Always turn the fuel tank valve (if so equipped) to OFF position when the watercraft is not in use.

Recommended Fuel

Use unleaded regular gasoline with the following recommended minimum octane number.

LOCATION	OCTANE NUMBER
Inside North America	87 octane (RON + MON)/2
Outside North America	91 RON

NOTE: Do not mix oil with fuel except if otherwise specified, at engine break-in. Refer to BREAK-IN PERIOD. Always check injection oil reservoir level when refueling.

CAUTION: Never experiment with other fuels or fuel ratios. Never use fuel containing more than 10% alcohol, (ethanol or methanol). The use of non-recommended fuel can result in watercraft performance deterioration and damage to critical parts in the fuel system and engine components.

CAUTION: On RFI models, never use injector cleaning products. They may contain additive that could damage injector components.

Recommended Oil

WARNING

Do not overfill. Reinstall cap and fully tighten. Oil is flammable. Always wipe off any oil spillage from the bilge.

Use only two-stroke engine injection oil sold by authorized Sea-Doo dealers.

MODELS	OIL TYPE
GTI	XP-S synthetic 2-stroke oil OR XP-S mineral injection oil (or equivalent) ①②
GTI RFI, GTI LE RFI ③	XP-S synthetic 2-stroke oil

- ① If XP-S mineral injection oil is not available, API TC high-quality low ash two-stroke injection oil may be used.
- ② XP-S synthetic 2-stroke oil and XP-S mineral injection oil are compatible, they can be mixed together.

CAUTION: ③The XP-S synthetic 2-stroke oil is specially formulated and tested for the severe requirements of the 787 RFI engines. Use of any other brand two-stroke oil may void the limited warranty. Use only XP-S synthetic 2-stroke oil. There is no known equivalent on the market for the moment. If a high quality equivalent were available, it could be used.

XP-S mineral injection oil is a special blend of basic oil and additives especially selected to ensure unequalled lubrication, engine cleanliness and minimum spark plug fouling.

The XP-S synthetic 2-stroke oil provides superior lubrication, reduced engine component wear and oil deposit, thus maintaining maximum-level performance and antifriction properties. This synthetic injection oil meets the latest ASTM and JASO standards by ensuring high biodegradability and low exhaust smoke.

CAUTION: Never use four-stroke petroleum or synthetic motor oil and never mix these with outboard motor oil. Do not use NMMA TC-W, TC-W2 or TC-W3 outboard two-stroke engine oils or ashless two-stroke engine oils. Avoid mixing different brands of API TC oil as resulting chemical reactions may cause severe engine damage.

Oil Injection System

This watercraft features an oil injection system which does not require manual fuel/oil mixing.

A sufficient amount of injection oil should be maintained in the reservoir.

NOTE: It is recommended to carry a 1 L of spare injection oil.

The use of a funnel is recommended to pour the oil into the reservoir. Stop filling as soon as oil appears at approximately 13 mm (1/2 in) from top of reservoir. Do not overfill.

CAUTION: Always maintain a sufficient amount of injection oil in the oil reservoir. Check and refill every time you refuel if necessary. Do not overfill. If the engine runs out of oil, severe engine damage will occur. If the oil reservoir is found almost empty, air can enter in the system and it should be bled. Immediately refer to an authorized Sea-Doo dealer to have the oil injection system inspected.

BREAK-IN PERIOD

CAUTION: Scrupulously follow the instructions of this section. Failure to do so may reduce the engine's life and/or performance.

With Sea-Doo watercraft powered by Rotax® engines, a break-in period of 10 hours is required before continuous operation at full throttle.

To achieve a good break-in, throttle lever should not be depressed more than 3/4, however, brief acceleration and speed variations contribute to a good break-in.

CAUTION: Continued wide open throttle runs and prolonged cruising without speed variations should be avoided, this can cause engine damage during the break-in period.

Carburetor-Equipped Models

To assure additional protection during the initial engine break-in, it is recommended to add 1 L of the same oil as in the injection oil reservoir in the fuel tank for the first full fuel tank filling only.

To add injection oil in the fuel tank, proceed as follows:

Fill fuel tank with approximately 15 liters (4 gal) of gasoline; then, add the injection oil in the fuel.

NOTE: Fill up fuel tank with gasoline. Do not overfill.

NOTE: It is important to proceed in this order to allow a proper mixing of the oil in the gasoline. If oil is added first in an empty fuel tank, fuel lines will be filled up with injection oil, which will keep the engine from starting.

CAUTION: Remove and clean spark plugs after engine break-in.

RFI Models

NOTE: Do not add injection oil in the fuel tank for the break-in.

All Models

10-Hour Inspection

It is highly recommended that after the first 10 hours of operation, the watercraft be checked by an authorized Sea-Doo dealer. This inspection will also provide the opportunity to discuss the unanswered questions you may have encountered during the first hours of operation.

The 10-hour inspection is at the expense of the watercraft owner.

PRE-OPERATION CHECKS

WARNING

The pre-operation check is very important prior to operating the watercraft. Always check the proper operation of critical controls, safety features and mechanical components, before starting as listed hereinafter. If not done as specified here, severe injury or death might occur. Bring all safety equipment required by local laws.

Some of the following items may not have been previously covered in this guide, however they will be described in the MAINTENANCE or SPECIAL PROCEDURES section. Please refer to these sections to have more detailed information.

WARNING

Engine should be off and the safety lanyard should always be removed from its post prior to verifying any of the following points. Only start watercraft once all items have been checked and operate properly.

ITEM	OPERATION	✓
Hull	Inspect.	
Jet pump water intake	Inspect/clean.	
Bilge	Drain. Ensure plugs are secured.	
Water flow in cooling system (only when temperature is below or close to freezing point)	Check if water properly flows out at jet pump.	
Battery	Inspect tightness of cables and retaining strap(s).	
Fuel tank and oil reservoir	Refill.	
Engine compartment	Check fuel line connections for tightness. Check for any fuel leak/odor.	
Steering system and side vanes	Check operation.	
Throttle system	Check operation.	
Shifter system	Check operation.	
Storage compartment covers and seat	Ensure they are closed and latched.	
Safety lanyard and engine start/stop button	Check operation.	

NOTE: See the detailed instructions hereinafter.

Hull

Inspect hull for cracks or damage.

Jet Pump Water Intake

Remove weeds, shells, debris or anything else that could restrict the flow of water and damage cooling system or propulsion unit. Clean as necessary. If any obstruction can not be removed, refer to an authorized Sea-Doo dealer for servicing.

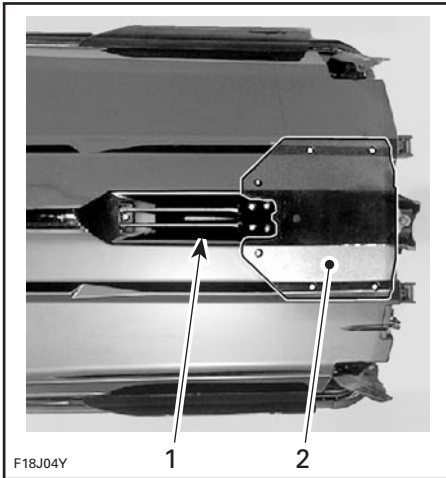

TYPICAL

1. Water intake
2. Ride plate

Inspect leading edges of the impeller, if they have nicks or bends performance will be greatly reduced.

Bilge

Should water be present in the bilge, tilt the watercraft to the rear and unscrew drain plugs to completely empty the bilge.

Secure bilge drain plugs.

WARNING

Make sure drain plugs are properly secured prior to launching the watercraft in water.

Water Flow in Cooling System (only when temperature is below or close to freezing point)

In Northern areas, if watercraft is to be used when temperature is below or close to freezing point (0°C (32°F)) or if watercraft was left unused while temperature was below or close to freezing point, water may be frozen in cooling system hoses. This could cause cooling system overheating. To ensure it is properly working, do the following prior to using the watercraft:

- The procedure is to be performed with watercraft out of water.
- Connect a garden hose to the flushing connector at jet pump.
- Perform the flushing operation as explained in POST-OPERATION CARE.
- Ensure water flows out of jet pump. Otherwise, water is frozen in cooling system and restricts water flow. Do not operate the watercraft in this condition.

NOTE: Pay attention that some water will also flow out of exhaust outlet. Make sure water is effectively flowing out of jet pump.

CAUTION: Operating watercraft with frozen water in cooling system might lead to engine components damage.

NOTE: When water freezes, damage to engine components should not occur because of water expansion, but because it prevents full flow of cooling water.

- Either wait until ice melts or pour some hot water to cooling system components and to engine. Then, perform the flushing operation again to make sure water properly flows out of jet pump. If you need assistance, refer to an authorized Sea-Doo dealer.

WARNING

Do not use any electrical heating device to heat the cooling system. Electrical devices may generate sparks that would ignite fuel vapors that might be present in the bilge causing a fire or an explosion.

- Ensure to drain bilge if water is present.

Battery

WARNING

Verify tightness of battery cables to their posts and condition of battery retaining strap(s)/fasteners. Do not charge or boost battery while installed.

Fuel Tank and Oil Reservoir

With the watercraft horizontal, fill the fuel tank to specified level.

Check the oil level and refill reservoir as necessary.

Check fuel tank and oil reservoir retaining straps/fasteners.

Engine Compartment

WARNING

Should any leak or gasoline odor be present, do not start the engine. Refer to an authorized Sea-Doo dealer before use.

Steering System

Assisted by another person, check steering operation for free movement. When the handlebar is horizontal, the jet pump nozzle should be in the straight ahead position. The rear edge of side vanes should be pointing outside of watercraft by approximately 20°. Ensure the jet pump nozzle and side vanes pivot easily and in the same direction as the handlebar.

WARNING

Check handlebar and corresponding steering nozzle operation before starting. Never turn handlebar while someone is nearby rear of watercraft. Keep away from steering moving parts (nozzle, side vanes, linkage etc.).

Throttle System

Check throttle lever for free and smooth operation. It should return to its initial position immediately after it is released.

WARNING

Check throttle lever operation before starting the engine.

Carburetor-Equipped Models

CAUTION: Engine can be flooded if throttle lever is applied several times when engine is not running. If engine is flooded, it will not start.

Shifter System

Check reverse gate operation for free movement. With shift lever in forward position, the gate should be in upward position and offering a resistance to go downward. With the shift lever in neutral position, gate should be in middle position. With shift lever in reverse position, gate should be in downward position.

 **WARNING**

Verify the reverse gate operation before starting the engine.

Storage Compartment Covers and Seat

Ensure they are closed and latched.

 **WARNING**

Make sure seat is securely latched.

Safety Lanyard and Engine Start/Stop Button

Position shift lever in neutral. Ensure that both switches operate properly. Start engine and stop it using each switch individually.

 **WARNING**

Should the safety lanyard cap be loose or fail to remain on its post, replace it immediately in order to avoid unsafe use.

 **WARNING**

If engine does not shut-off when pushing engine start/stop button or by disconnecting the safety lanyard, stop the engine by applying the choke and turning fuel tank valve (if so equipped) to OFF position. Do not operate the watercraft further, see an authorized Sea-Doo dealer.

OPERATING INSTRUCTIONS

⚠ WARNING

Always perform the PRE-OPERATION CHECKS before operating the watercraft. Become thoroughly familiar with all controls and the function of each. Should any control or instruction not be fully understood, refer to an authorized Sea-Doo dealer.

Principle of Operation

Propulsion

The engine is directly coupled to a drive shaft which, in turn, rotates an impeller. This impeller is accurately adjusted in a housing where the water is drawn up from underneath the watercraft. Then the water flows through the impeller to a venturi. The venturi accelerates the water and produces thrust to move the watercraft. Depressing the throttle lever increases engine speed and therefore watercraft speed.



TYPICAL

⚠ WARNING

Whenever the engine is to be started, the operator and passenger(s) should always be properly sitting on the watercraft and be wearing protective clothing including a Coast Guard approved PFD and a wet suit bottom.

⚠ WARNING

Keep away from intake grate while engine is on. Items such as long hair, loose clothing or personal flotation device straps can become entangled in moving parts resulting in severe injury or drowning.

The shift lever should be in the forward position in order for the watercraft to advance.

Neutral and Reverse

⚠ WARNING

Never use jet pump components as a supporting point to board the watercraft. Shift lever should only be used when the engine is idling and watercraft is completely stopped. Never rev the engine at high RPM in reverse. Do not use reverse to stop the watercraft. Only use reverse at slow speed and for the shortest time possible. Always ensure the path behind is clear of objects and persons including children playing in shallow water.

To find the neutral, set in reverse then push back until the watercraft stops moving backwards.

The reverse gate will be in the middle position, directing half of the thrust toward the front of the watercraft to minimize watercraft movement.

⚠ WARNING

When the watercraft is in neutral position, the drive shaft and impeller are still turning.

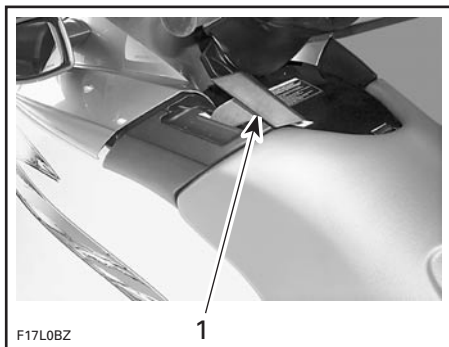

1. Shift lever in neutral position

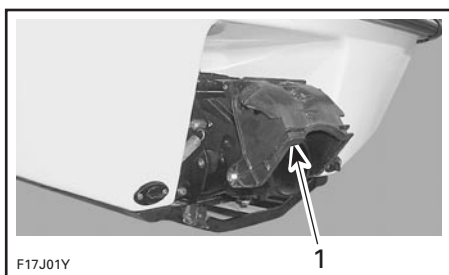

1. Reverse gate in middle position

To obtain reverse, pull shift lever completely. The reverse gate will be in downward position, directing all the thrust toward the front of the watercraft.

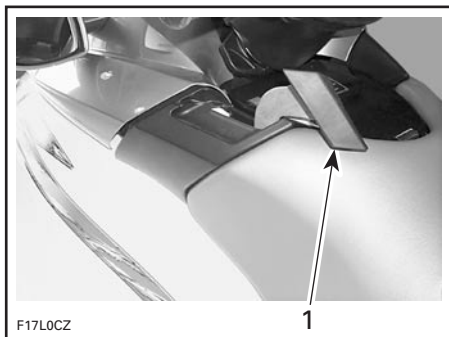

1. Shift lever in reverse position

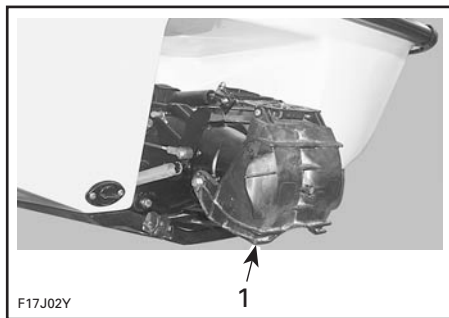

1. Reverse gate in downward position

NOTE: To obtain maximum efficiency and control from the reverse, increase engine speed to slightly above idle. Too much RPM will create water turbulence and reduce reverse efficiency.

In reverse position, turn the handlebar in the same direction that you want to move the rear of the watercraft.

For example, to steer the rear of the watercraft to the left side, turn the handlebar to the left side.

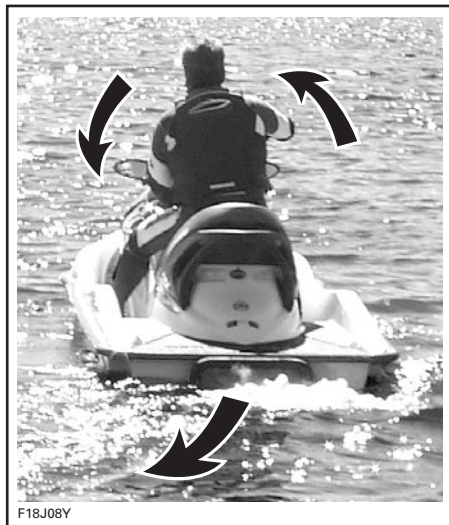

⚠ WARNING

Shift lever should only be used when the engine is idling and watercraft is completely stopped. Do not use reverse to stop the watercraft.

Steering



Turning the handlebar pivots the jet pump nozzle which controls the watercraft direction. Turning the handlebar to the right will turn the watercraft to the right and inversely. The throttle should be applied to turn the watercraft.

⚠ WARNING

Throttle should be applied and handlebar turned to change the direction of the watercraft. Steering efficiency will differ depending on the number of passengers, load, water conditions and environmental factors such as the wind.

Unlike a car, a watercraft needs some throttle to turn. Practice in a safe area applying the throttle and turning away from an imaginary object. This is a good collision avoidance technique.

⚠ WARNING

Directional control is reduced when the throttle is released and/or when engine is off.

The watercraft behaves differently with a passenger and requires greater skill. The passenger should always grip the seat strap or grab handle. Reduce speed and avoid sharp turns. Avoid choppy water conditions when carrying a passenger.

CAUTION: Combustion engine needs air to operate; consequently this watercraft cannot be totally watertight. Any maneuvers such as figure eights etc., that cause the upper deck to be under water may cause severe engine problems due to water ingestion. Refer to SPECIAL PROCEDURES and LIMITED WARRANTY contained in this section.

Two side vanes on the rear sides of the hull, turn as the steering is turned to assist the watercraft turning. At first, carefully experiment turning with this system.

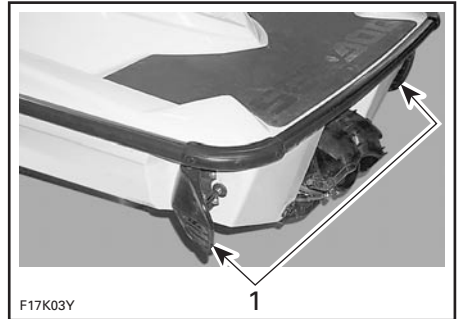

1. Side vanes turn following steering movement

Boarding the Watercraft

General

As with any watercraft, boarding should be done carefully and engine should not be running.

WARNING

Engine should be OFF when boarding the watercraft or when using boarding step (if so equipped). Keep limbs away from jet or intake grate. Stay on center of the step. Only one person at a time on the step. Never use the step for pulling, towing, diving or jumping, boarding a watercraft that is out of water or any other purpose other than a boarding step.

On some models, boarding is facilitated by using a step.

WARNING

Inexperienced riders should practice how to get aboard (all methods explained here) close to shore first before venturing into deep water.

WARNING

Never use jet pump components as a supporting point to board the watercraft.

Boarding from a Dock or in Shallow Water

When boarding from a dock, slowly place one foot on the watercraft foot-board nearest the dock and, at the same time, transfer the body weight to the other side in order to balance the watercraft while holding the handlebar. Then, bring the other foot over the seat and put it on the other foot-board. Push the watercraft away from the dock.



In shallow water, board the watercraft either from the side or the rear.

Ensure there is at least 90 cm (3 ft) of water underneath the lowest rear portion of the hull.

Take into account that the hull will lower in water when all passengers are aboard. Be certain to maintain the specified depth so sand, pebbles and rocks will not be drawn up in the jet pump.

CAUTION: Starting the engine or riding the watercraft in shallower water might damage the impeller or other jet pump components.



1. Maintain at least 90 cm (3 ft) underneath the lowest rear portion of the hull when all passengers are aboard

Boarding in Deep Water

Operator Alone

Swim to the rear of the watercraft.

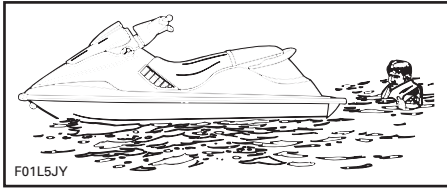

Grip the grab handle and pull yourself upward until your knee can reach the boarding platform then grip the seat strap.

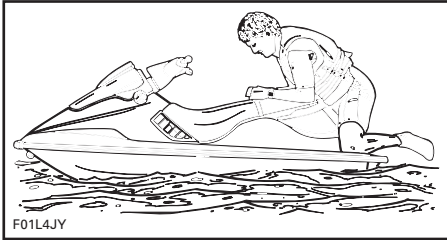

Bring your feet on the footboard while maintaining balance using the handlebar (except 3-up seat models).

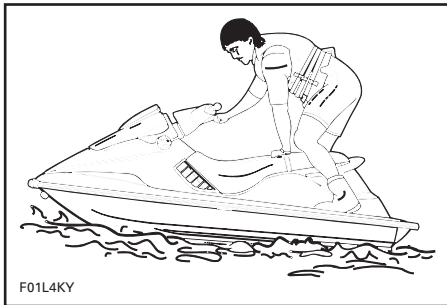

Sit astride the seat.

Operator with a Passenger

The operator climbs on the watercraft the same way as explained previously.

In choppy water, the passenger, while in the water, may hold the watercraft to help the operator in climbing aboard.

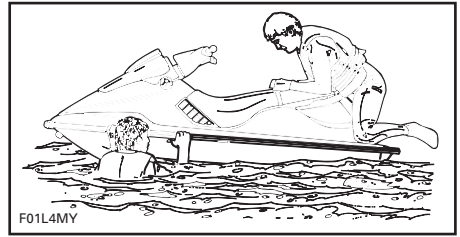

The passenger then climbs on the watercraft while the operator maintains balance by sitting as close as possible to the console.

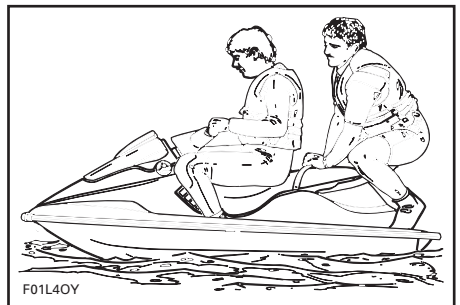
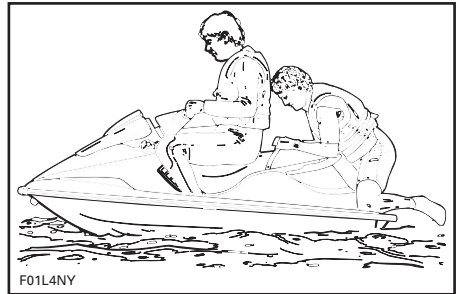

Starting

Preparation

Before unloading the watercraft from the trailer, it can be started for about 10 seconds to verify proper operation.

WARNING

Components inside engine compartment may be hot. Do not touch electrical parts or jet pump area when engine is running.

Attach the safety lanyard to your PFD and snap the cap to its post before starting the engine.

NOTE: If you hear anything else than 2 short beeps from DESS system, it indicates a particular condition that should be corrected. Refer to the TROUBLESHOOTING section for the meaning of the coded signal.

WARNING

Before starting the engine, the operator and passengers should always be properly seated.

Position shift lever to neutral.

Turn the fuel tank valve (if so equipped) to ON position.

Firmly grip handlebar with your left hand and place both feet on the footboards.

CAUTION: Ensure there is at least 90 cm (3 ft) of water underneath the lowest rear portion of the hull when all passengers are aboard prior to starting the engine. Otherwise damage to the impeller or other jet pump components might occur. Do not accelerate abruptly.

To start engine, depress and hold the engine start/stop button. Follow procedure below for cold or warm engine starting.

If engine fails to start after 10 seconds, wait a few seconds then repeat procedure.

CAUTION: Do not hold start/stop button more than 30 seconds to avoid starter overheating. A rest period should be observed between the cranking cycles to let starter cool down. Pay attention not to discharge battery.

Release engine start/stop button immediately after engine is started.

Carburetor-Equipped Models

Cold Engine

The choke is provided to supply a richer fuel/air mixture when starting a cold engine.

Fully pull the choke lever and hold while starting the engine.

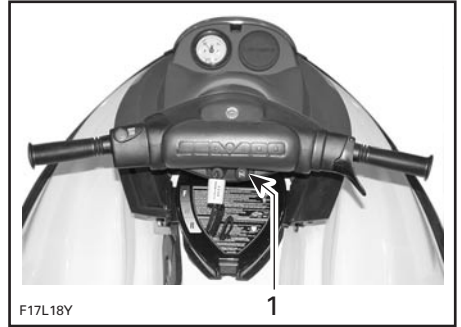

1. Fully pull

After engine is started, release choke lever.

It may be necessary to reapply the choke and if necessary, slightly apply throttle to keep engine running.

Warm Engine

The choke does not need to be applied.

RFI Models

Cold and Warm Engine

Do not depress the throttle lever to start either a cold or warm engine.

All Models

Riding

Slowly accelerate to reach deeper water. Do not apply full throttle until the engine is warm.



CAUTION: Avoid watercraft operation in weeded areas. If unavoidable, vary watercraft speed.

Rough Water or Poor Visibility Operation

Avoid operation in these conditions. If you must do so, proceed with caution and prudence using minimum speed.

Crossing Waves

Reduce speed.

Always be prepared to steer and balance as necessary.

When crossing wakes, always keep a safe distance from watercraft ahead.

WARNING

When crossing wakes, slow down. Operator and passenger(s) can brace themselves by posting. Do not jump waves or wakes.

Stopping/Docking

The watercraft is slowed by water drag. The stopping distance will vary depending on the watercraft size, weight, speed, water surface condition, presence and direction of wind and current.



The operator should become familiarized with the stopping distance under different conditions.

Release the throttle at a sufficient distance before the expected landing area.

Reduce speed to idle.

Shift to neutral, reverse or forward, as required.

WARNING

Directional control is reduced when the throttle is released and/or when engine is off.

Beaching

CAUTION: It is not recommended to run the watercraft to the beach.

Come slowly to the beach and shut off the engine using the safety lanyard before water depth is less than 90 cm (3 ft) under the lowest rear portion of the hull, then pull the watercraft to the beach.

CAUTION: Riding the watercraft in shallower water might damage the impeller or other jet pump components.



CAUTION: Pay attention, when leaving the watercraft on the beach, so that the side vanes do not rub or hit the ground due to the rocking movement. It might eventually damage components of the O.P.A.S. system.

Shutting Off the Engine

To keep watercraft directional control, the engine should be running until the watercraft is at idle.

To shut off the engine, completely release throttle lever and press the engine start/stop button. Remove safety lanyard from watercraft.

WARNING

Should the engine be shut off, watercraft directional control is reduced. Never leave the safety lanyard on its post when watercraft is not in operation in order to prevent accidental engine starting or to avoid unauthorized use by children or others or theft.

POST-OPERATION CARE

WARNING

Allow engine to cool before performing any maintenance.

General Care

Remove the watercraft from the water every day to prevent marine organisms growth.

Should any water be present in the hull, unscrew the drain plugs and tilt the watercraft to the rear in order to allow water to flow out.

Wipe up any remaining fluid in the engine compartment (bilge, engine, battery, etc.) with clean dry rags (this is particularly important in salt water use).

Additional Care for Foul Water or Salt Water

When the watercraft is operated in foul water and particularly in salt water, additional care should be taken to protect the watercraft and its components. Rinse trailer and watercraft's bilge area with fresh water.

CAUTION: Failure to perform proper care such as: watercraft rinsing, cooling system flushing and anti-corrosion treatment, when watercraft is used in salt water, will result in damage to the watercraft and its components. Never leave the watercraft stored in direct sunlight.

Cooling System Flushing and Engine Internal Lubrication

General

Flushing the cooling system with fresh water is essential to neutralize corroding effects of salt or other chemical products present in water. It will help to remove sand, salt, shells or other particles in water jackets (engine, exhaust manifold, tuned pipe) and/or hoses.

Engine lubrication and flushing should be performed when the watercraft is not expected to be used further the same day or when the watercraft is stored for any extended time.

WARNING

Perform this operation in a well ventilated area.

Proceed as follows:

Clean jet pump by spraying water in its inlet and outlet and then apply a coating of BOMBARDIER LUBE lubricant or equivalent.

Connect a garden hose to connector located at the rear of watercraft on jet pump support.

NOTE: A quick connect adapter can be used (P/N 295 500 473). No hose pincher is required to flush engine.

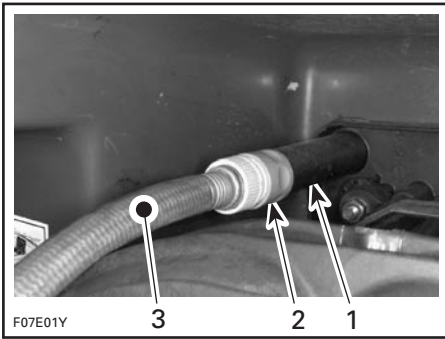

TYPICAL

1. Hose adapter
2. Quick connect adapter (not mandatory)
3. Garden hose

NOTE: The quick connect adapter may be supplied with some models. It has to be removed if you do not use a quick connect adapter on your garden hose.

Flushing and Lubrication

To flush cooling system, start the engine then immediately open the water tap.

⚠ WARNING

Components inside engine compartment may be hot. Do not touch any electrical parts or jet pump area when engine is running.

CAUTION: Never flush a hot engine. Always start the engine before opening the water tap. Open water tap immediately after engine is started to prevent overheating.

Run the engine about 3 minutes at a fast idle around 3500 RPM.

Ensure water flows out of drain lines (engine crankcase, engine cylinder) while flushing. Otherwise, clean the lines.

CAUTION: Never run engine longer than 5 minutes. Drive line seal has no cooling when watercraft is out of water.

Spray BOMBARDIER LUBE lubricant or equivalent, through hole of air intake silencer keeping engine at fast idle during one minute.

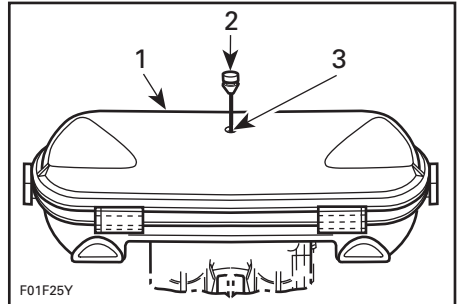

717 AND 787 RFI ENGINES

1. Air intake silencer
2. Pull plug
3. Spray BOMBARDIER LUBE here

Lubrication of engine should be done for at least 1 minute.

After approximately half a minute, close fuel valve to run engine out of fuel while lubricating.

CAUTION: When engine begins to run irregularly because of fuel starvation, immediately stop water flow before engine dies.

Close the water tap then stop the engine.

CAUTION: Always close the water tap before stopping the engine.

Final Steps

Disconnect the garden hose.

Remove spark plug cables and connect them on the grounding device.

⚠ WARNING

Always use spark plug cable grounding device when removing spark plugs.

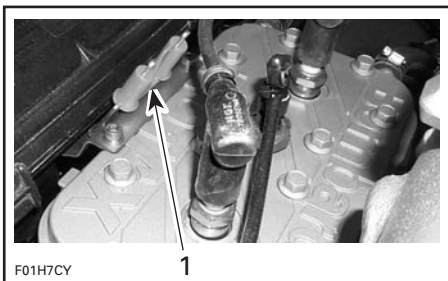

GTI MODELS
1. Grounding device

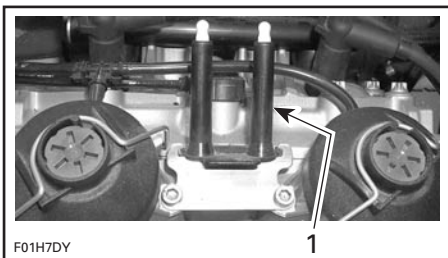

GTI RFI AND GTI LE RFI MODELS
1. Grounding device

Remove both spark plugs and spray BOMBARDIER LUBE lubricant or equivalent into each cylinder.

Carburetor-Equipped Models

Crank the engine a few turns to distribute the oil on cylinder wall.

RFI Models

Remove safety lanyard from its post.

Depress the throttle lever at full throttle position and hold.

Reinstall the safety lanyard cap on its post.

Crank the engine a few turns to distribute the oil on cylinder wall.

NOTE: Proceeding in this order, no fuel will be injected into the engine.

All Models

Apply anti-seize lubricant on spark plug threads then reinstall them.

Properly reconnect spark plug cables to spark plugs.

Wipe up any residual water from the engine.

Reinstall plug on air intake silencer cover.

Anticorrosion Treatment

To prevent corrosion, spray a corrosion inhibitor (salt water resistant) such as BOMBARDIER LUBE lubricant or equivalent over metallic components in engine compartment.

Apply dielectric grease (salt water resistant) on battery posts and cable connectors.

CAUTION: Never leave rags or tools in the engine compartment or in the bilge.

SPECIAL PROCEDURES

Monitoring System

To assist you when using the watercraft, a system monitors some component of the watercraft and sends audible signals through a beeper to inform you of a particular condition. Refer to the TROUBLESHOOTING section for the coded signals chart.

Engine Overheating

CAUTION: If the monitoring beeper continuously sounds, stop engine immediately.

Perform JET PUMP WATER INTAKE AND IMPELLER CLEANING procedure described in this section.

When back to shore, flush cooling system, refer to POST-OPERATION CARE.

If engine still overheats, refer to an authorized Sea-Doo dealer for servicing.

Jet Pump Water Intake and Impeller Cleaning

WARNING

Keep away from intake grate while engine is on. Items such as long hair, loose clothing or personal flotation device straps can become entangled in moving parts resulting in severe injury or drowning.

Weeds, shells or debris can get caught on the intake grate, drive shaft and/or impeller. A clogged water intake may cause troubles such as:

1. **Cavitation:** Engine speed is high but watercraft moves slowly due to reduced jet thrust, jet pump components may be damaged.

2. **Overheating:** Since the jet pump operation controls the flow of water to cool the engine, a clogged intake will cause the engine to overheat and damage engine internal components.

A weed clogged area can be cleaned as follows:

In-Water Cleaning

Rock the watercraft several times while repeatedly pressing engine start/stop button for short period without starting engine. Most of the time, this will remove the blockage. Start engine and make sure water flows out from bleed outlet and watercraft operates properly.

If system is still blocked, move the watercraft out of the water and remove blockage manually.

If the aforementioned method does not work, the following can be performed:

- With engine running and before applying throttle, put shift lever in reverse position and vary throttle quickly several times.
- Repeat procedure if necessary.

On-Beach Water Cleaning

WARNING

Always remove safety lanyard cap from its post to prevent accidental engine starting before cleaning the jet pump area.

Place a cardboard or a carpet beside the watercraft to prevent scratching when turning the watercraft for cleaning.

Rotating watercraft in the proper direction eliminates the possibility of residual water in the tuned pipe entering the engine and causing engine damage.

GTI Models

Rotate the watercraft counterclockwise (seen from rear) to its left side for cleaning.

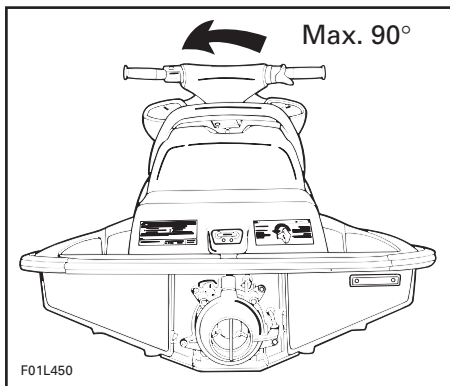

TYPICAL

GTI RFI and GTI LE RFI Models

Rotate the watercraft clockwise (seen from rear) to its right side for cleaning.

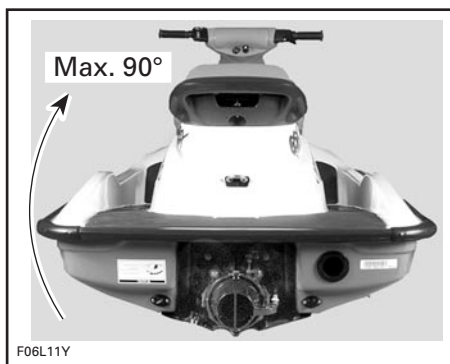

Clean the water intake area. If the system is still clogged, refer to an authorized Sea-Doo dealer for servicing.

CAUTION: Inspect water intake grate for damage. Refer to an authorized Sea-Doo dealer for repair as necessary.

Capsized Watercraft

The watercraft is designed so that it should not turn over easily. Also two sponsons mounted on the side of the hull assist watercraft stability. If it turns over, it will remain capsized.

WARNING

When watercraft is capsized, do not attempt to restart the engine. Operator and passengers should always wear approved personal flotation devices.

CAUTION: Always refer to decal located on stern of watercraft.

To return the watercraft upright, ensure the engine is off, grab the inlet grate, step on bumper rail and use your weight to rotate the watercraft.

GTI Models

Rotate the watercraft clockwise (seen from rear).

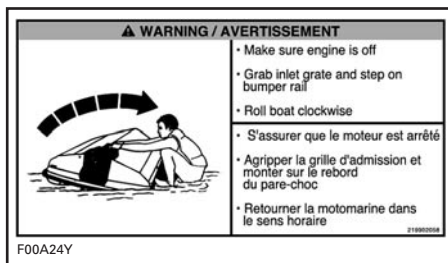

GTI RFI and GTI LE RFI Models

Rotate the watercraft counterclockwise (seen from rear).

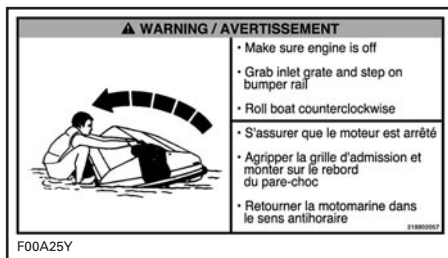

Submerged Watercraft

To limit damages to the engine, perform the following procedure as soon as possible.

Drain bilge.

If it was submerged in salt water, spray bilge and all components with fresh water using a garden hose to stop the salt corroding effect.

CAUTION: Never try to crank or start the engine. Water trapped in engine may cause severe damage to the engine components.

Bring the watercraft to be serviced by an authorized Sea-Doo dealer as soon as possible.

CAUTION: The longer the delay before you have the engine serviced, the greater the damage will be to the engine.

Water-Flooded Engine

In the event the engine cannot be serviced within a few hours, remove spark plug cables and connect them on the grounding device.

WARNING

Never crank engine with spark plugs removed unless spark plug cables are connected to the grounding device. Be careful when cranking engine, water will spray out from spark plug holes.

Remove spark plugs and dry them with a clean and dry cloth.

Cover spark plug holes with a rag.

Carburetor-Equipped Models

Ensure choke lever is completely pushed in.

Fully depress the throttle lever and hold.

RFI Models

To prevent fuel to be injected in the engine, proceed as follows.

Remove safety lanyard from its post.

Depress and hold the throttle lever at full throttle position. Wait 2 seconds then, reinstall the safety lanyard cap while keeping throttle lever fully depressed.

Crank engine several times to allow water to escape from spark plug openings.

Release throttle lever.

Spray BOMBARDIER LUBE lubricant or equivalent into spark plug holes.

Crank engine again.

Reinstall spark plugs. Install clean dry spark plugs if possible. Reconnect cables.

Start engine normally.

It is recommended to bring the vehicle to an authorized Sea-Doo dealer for further inspection and care.

Fuel-Flooded Engine

When the engine does not start after several attempts, the engine may be fuel-flooded. Proceed as follows.

Carburetor-Equipped Models

Install the safety lanyard cap on its post.

Ensure choke lever is completely pushed in.

Fully depress the throttle lever and hold while starting the engine. Try several times.

Crank the engine a few turns to distribute the oil on cylinder wall.

RFI Models

To prevent fuel to be injected in the engine, proceed as follows.

While engine is stopped, fully depress throttle lever and HOLD for cranking.

Crank engine approximately 5 seconds.

Release throttle lever and crank engine.

All Models

If it does not work:

Remove spark plug cables and connect them on the grounding device.

WARNING

Always use spark plug cable grounding device when removing spark plugs. Never crank engine with spark plugs removed unless spark plug cables are connected to the grounding device.

Remove spark plugs and dry them using a rag.

Cover spark plug holes with a rag.

Crank engine several times (while keeping throttle fully depressed on RFI models).

Reinstall spark plugs. Install clean dry spark plugs if possible. Reconnect cables.

Start engine as explained above. If engine continues to flood, see an authorized Sea-Doo dealer.

Towing the Watercraft in Water

Special precautions should be taken when towing a Sea-Doo watercraft in water.

Maximum recommended towing speed is 24 km/h (15 MPH).

When towing your watercraft in water, pinch the water supply hose from the impeller housing to the engine with a large hose pincher (P/N 529 032 500).

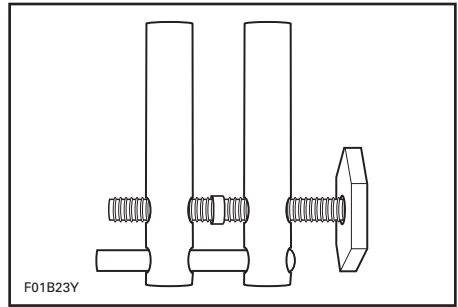

This will prevent the cooling system from filling which may lead to water being injected into and filling the exhaust system. Without the engine running there isn't any exhaust pressure to carry the water out the exhaust outlet.

CAUTION: Failure to do this may result in damage to the engine. If you must tow a stranded watercraft in water and do not have a hose pincher, be sure to stay well below the maximum towing speed of 24 km/h (15 MPH).

Snugly install the hose pincher on the water supply hose as shown.

NOTE: A red tape on the water supply hose indicates which hose to pinch.

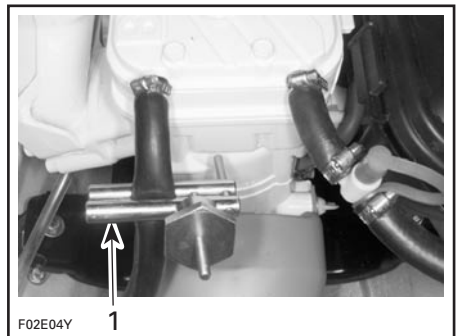

GTI MODELS

1. Hose pincher

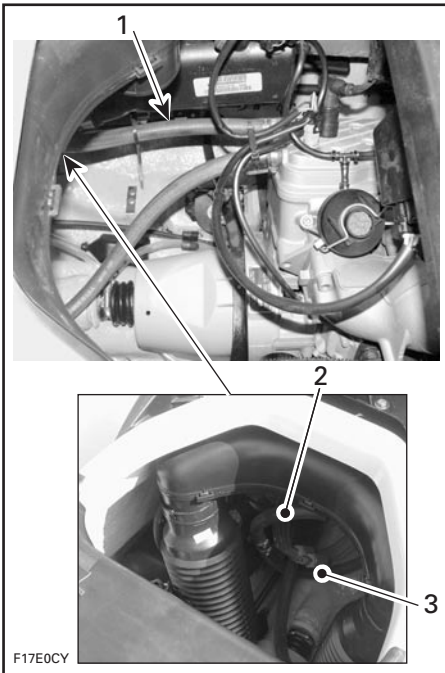

GTI RFI AND GTI LE RFI MODELS

1. Follow this hose towards rear
2. Hose coming from engine
3. Install hose pincher here on this side of the T-fitting

CAUTION: When finished towing the watercraft, hose pincher must be removed before operating it. Failure to do so will result in damage to the engine.

Low-Charge Battery Condition

See an authorized Sea-Doo dealer to have it charged or replaced.

WARNING

Do not charge or boost the battery while installed on the watercraft. Electrolyte is poisonous and dangerous. Avoid contact with eyes, skin and clothing.

MAINTENANCE INFORMATION

Maintenance, replacement, or repair of the emission control devices and systems may be performed by any marine SI (spark ignition) engine repair establishments or individual.

Engine Emissions Information

Manufacturer's Responsibility

Beginning with 1999 model year engines, PWC manufacturers of marine engines must determine the exhaust emission levels for each engine horsepower family and certify these engines with the United States of America Environmental Protection Agency (EPA). An emissions control information label, showing emission levels and engine specifications, must be placed on each vehicle at the time of manufacture.

Dealer's Responsibility

When performing service on all 1999 and more recent Sea-Doo watercrafts that carry an emissions control information label, adjustments must be kept within published factory specifications.

Replacement or repair of any emission related component must be executed in a manner that maintains emission levels within the prescribed certification standards.

Dealers are not to modify the engine in any manner that would alter the horsepower or allow emission levels to exceed their predetermined factory specifications.

Exceptions include manufacturer's prescribed changes, such as altitude adjustments for example.

Owner Responsibility

The owner/operator is required to have engine maintenance performed to maintain emission levels within prescribed certification standards.

The owner/operator is not to, and should not allow anyone to modify the engine in any manner that would alter the horsepower or allow emissions levels to exceed their predetermined factory specifications.

EPA Emission Regulations

All new 1999 and more recent Sea-Doo watercraft manufactured by BRP are certified to the EPA as conforming to the requirements of the regulations for the control of air pollution from new watercraft engines. This certification is contingent on certain adjustments being set to factory standards. For this reason, the factory procedure for servicing the product must be strictly followed and, whenever practicable, returned to the original intent of the design.

The responsibilities listed above are general and in no way a complete listing of the rules and regulations pertaining to the EPA requirements on exhaust emissions for marine products. For more detailed information on this subject, you may contact the following locations:

VIA U.S. POSTAL SERVICE:

Office of Mobile Sources Engine Programs and Compliance Division Engine Compliance Programs Group (6403J) 401 M St. NW Washington, DC 20460

VIA EXPRESS or COURIER MAIL:

Office of Mobile Sources Engine Programs and Compliance Division Engine Compliance Programs Group (6403J) 501 3rd St. NW Washington, DC 20001

EPA INTERNET WEB SITE:

www.epa.gov

General

- Only perform servicing procedures which are detailed in this guide. Further assistance or information can be obtained from your authorized Sea-Doo dealer. In many instances proper tools and training is required for certain servicing or repair procedures.
- Maintain the watercraft and equipment in top condition at all times. Adhere to the prescribed maintenance schedules. An annual inspection of the watercraft is always a good recommendation that should be followed.
- Always use spark plug cable grounding device when removing spark plugs.
- The bilge should be kept clean of oil, water or other foreign materials.
- Do not attempt to lift the watercraft without special equipment and training.
- The engine and the corresponding components identified in this guide should not be utilized on product(s) other than for which they were designed. Maintenance procedures and specified tightening torque should be strictly adhered to. Never attempt repairs unless the appropriate tools are available. These watercrafts are designed with parts dimensioned in both the metric and the imperial systems. When replacing fasteners, make sure to use only those recommended by BRP. If required, contact your authorized Sea-Doo dealer for further servicing information.

MAINTENANCE CHART

Periodic Inspection

Routine maintenance is necessary for all mechanized products. A periodic inspection contributes to the product's life span.

The following maintenance chart gives guidelines for regular watercraft servicing scheduled to be performed by you and/or by an authorized Sea-Doo dealer. The schedule should be adjusted according to operating conditions and use.

IMPORTANT: Schedule for watercraft rental operations or higher number of hour use, will require greater frequency of inspection and maintenance.

The maintenance is very important, if you are not familiar with safe service practices and adjustment procedures, see your authorized Sea-Doo dealer.

I: INSPECT, VERIFY, CLEAN, ADJUST, LUBRICATE OR REPLACE IF NECESSARY C: CLEAN L: LUBRICATE R: REPLACE	First 10 h	EVERY			TO BE PERFORMED BY
		25 h or 3 months	50 h or 6 months	100 h or 1 year	
GENERAL					
Lubrication/corrosion protection	L ①		L		Customer
ENGINE					
Support and rubber mount	I		I		Dealer
Exhaust system fasteners ④	I		I		Dealer
RAVE valve (if so equipped) ④			C	C	Dealer
Counterbalance shaft oil level (if so equipped)			I	I	Dealer
Spark plug	I ④		R		Dealer
TDC setting ④				I	Dealer
COOLING SYSTEM					
Flushing		C ③			Customer
Hose and fasteners	I		I		Dealer
Engine drain tubes		I ①			Customer
Water flow regulator valve (if so equipped)				I	Dealer

I: INSPECT, VERIFY, CLEAN, ADJUST, LUBRICATE OR REPLACE IF NECESSARY C: CLEAN L: LUBRICATE R: REPLACE	First 10 h	EVERY			TO BE PERFORMED BY
		25 h or 3 months	50 h or 6 months	100 h or 1 year	
FUEL SYSTEM					
Carburetor and fittings (if so equipped)	I			I	Dealer
Throttle cable (and choke cable if so equipped)	I ①	I			Dealer
Fuel filter (carburetor-equipped models)	I	I		R	Dealer
Fuel injection system sensors (except throttle body) ④ (RFI models)	I			I	Dealer
Throttle body and TPS ④⑤ (RFI models)	I		I		Dealer
Fuel lines, connections, check valve, relief valve and fuel system pressurization ④	I	I			Dealer
Air intake silencer fit/tightness	I			I	Dealer
Fuel tank straps	I			I	Dealer
LUBRICATION SYSTEM					
Oil injection pump ④	I			I	Dealer
Oil lines	I	I			Dealer
Oil filter	I	I		R	Dealer
Oil reservoir straps	I				Customer
ELECTRICAL SYSTEM					
Electrical connections and fastening (ignition system, starting system, fuel injectors, etc.) ④	I			I	Dealer
ECM and VCM mounting brackets/fasteners			I		Dealer
Digitally Encoded Security System and safety lanyard/post	I		I		Dealer
Monitoring beeper	I		I		Dealer
Battery and bracket(s)/fasteners	I		I		Dealer
STEERING SYSTEM					
Steering cable	I		I		Dealer

I: INSPECT, VERIFY, CLEAN, ADJUST, LUBRICATE OR REPLACE IF NECESSARY C: CLEAN L: LUBRICATE R: REPLACE	First 10 h	EVERY			TO BE PERFORMED BY
		25 h or 3 months	50 h or 6 months	100 h or 1 year	
O.P.A.S SYSTEM					
O.P.A.S. system	I		I		Dealer
PROPULSION SYSTEM					
Drive shaft protection hose			I ②		Dealer
Drive shaft boot/impeller splines			I ②		Dealer
PTO flywheel	L	L			Customer
Shifter system/cable	I			I	Dealer
Jet pump reservoir oil	R	I	R		Dealer
Jet pump cover pusher				I	Dealer
Impeller shaft seal				R ⑥	Dealer
Impeller and impeller/wear ring clearance				I ②	Dealer
Water intake grate			I ②		Customer
HULL AND BODY					
Bailer pick-ups, check for obstructions	I			I	Customer
Hull	I			I	Customer

NOTE: Some items are included in the PRE-OPERATION CHECKS and not necessarily repeated in this chart.

- ① Every 10 hours in salt water use.
- ② These items have to be initially checked after 25 hours. Thereafter, servicing to be made as specified in this chart.
- ③ Daily flushing in salt water or foul water use.
- ④ Emission-related component.
- ⑤ In salt water use.
- ⑥ Replace at 150 hours or after 2 years whichever comes first.

MAINTENANCE

WARNING

Only perform procedures as detailed in this guide. It is recommended that the assistance of an authorized Sea-Doo dealer be periodically obtained on other components/systems not covered in this guide. Unless otherwise specified, engine must not be running and the safety lanyard must be removed from its post for all maintenance procedures. Components inside engine compartment may be hot. Never use jet pump components or side vanes to lift the watercraft.

Lubrication

Use Sea-Doo synthetic grease or equivalent and lubricate PTO flywheel.

Proceed as follows:

Remove seat to expose engine compartment.

Remove vent tube support.

PTO Flywheel

Remove the fasteners and pull out PTO flywheel guard.

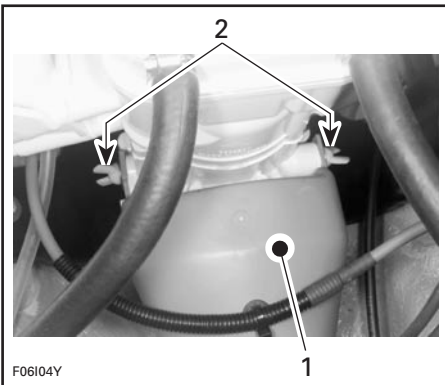

TYPICAL
1. Flywheel guard
2. Wing nuts

Using a grease gun, carefully lubricate PTO flywheel at grease fitting until PTO flywheel boot begins to expand.

CAUTION: Immediately stop lubricating as soon as PTO flywheel boot begins to expand to prevent damage or slipping.

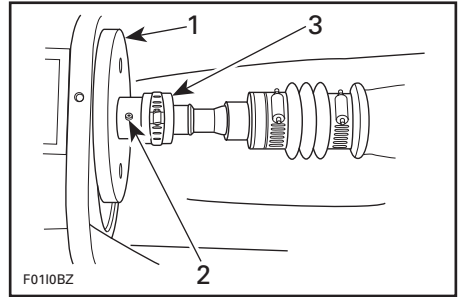

1. PTO flywheel
2. Grease fitting
3. PTO flywheel boot

Reinstall and secure PTO flywheel guard.

Anticorrosion Protection

Throttle/Choke Cables

Lubricate the throttle and choke cables (if so equipped) with BOMBARDIER LUBE lubricant or equivalent.

Electrical Connections

As necessary, apply anticorrosion product such as dielectric grease on battery posts and all exposed cable connectors.

CAUTION: Do not lubricate connectors of the Multi-Purpose Electronic Module.

Additional Lubrication

BOMBARDIER LUBE lubricant or equivalent will help prevent corrosion of metallic parts and maintain proper operation of moving mechanisms.

WARNING

Do not lubricate the safety lanyard post.

Carburetor-Equipped Models

Choke Lever

Fully pull choke lever and lubricate the metallic portion.

All Models

Seat Opening Mechanism, Tab, Hook and Lock Pin

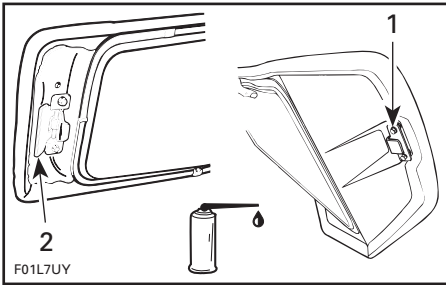

TYPICAL

1. Front tab
2. Rear mechanism

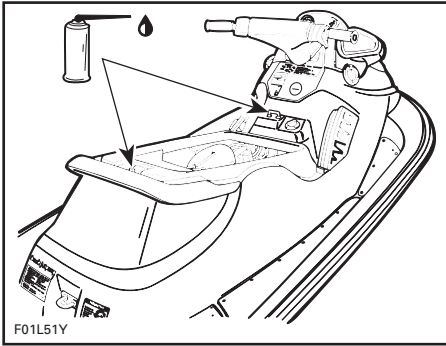

TYPICAL

Carburetor/Throttle Body and Oil Injection Pump

Lubricate springs, shafts and exposed portion of cables.

Reverse Gate

Lubricate pivoting points and mechanism.

Throttle and Choke Cable Inspection

Throttle Cable

Depress and release the throttle lever. It should operate smoothly and return to its initial position without any hesitation. Refer to an authorized Sea-Doo dealer if necessary.

Carburetor-Equipped Models

Do not activate throttle lever unnecessarily, when engine is not running. Carburetors are equipped with fuel accelerator pumps. These pumps deliver fuel to the engine each time throttle lever is depressed.

All Models

WARNING

Do not alter or tamper with throttle cable adjustment or routing.

WARNING

If throttle lever does not automatically return, do not operate watercraft and see your authorized Sea-Doo dealer.

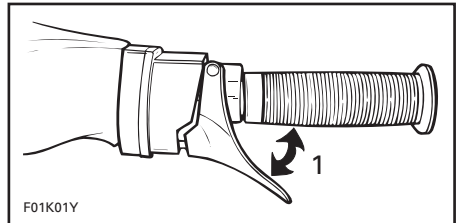

1. Should move freely

Carburetor-Equipped Models

Choke Cable

Ensure choke cable operates smoothly and without any hesitation from fully opened to fully closed. When the choke lever is fully pulled, choke should be fully applied. Refer to an authorized Sea-Doo dealer if necessary.

Carburetor Adjustment

There is no adjustment to be performed on the carburetor.

CAUTION: Trying to bypass the tamper-proof screws could damage the carburetor. It could also change the engine emission level and lead the engine not to meet the emission control regulations.

Fuel Injection System

RFI Models

The fuel injection system inspection should be performed by an authorized Sea-Doo dealer.

CAUTION: Never use injector cleaning products. They may contain additives that could damage injector components.

All Models

Fuel and Oil Filters

The fuel filter (carburetor-equipped models) and the oil filter should be replaced by an authorized Sea-Doo dealer. Fuel system pressurization should be conducted at the same time.

CAUTION: An obstructed oil filter will cause oil starvation resulting in serious engine damage.

Steering Alignment

When the handlebar is directed in straight ahead position, the jet pump nozzle should be in the same direction allowing the watercraft to run in a straight line. The rear edge of side vanes should be pointing out side by approximately 20° when the handlebar is pointing straight ahead.

Refer to an authorized Sea-Doo dealer if an adjustment is necessary.

WARNING

Ensure the handlebar and jet pump nozzle operate freely from side to side and are not stressing the steering cable or brackets. Never turn handlebar while someone is nearby rear of watercraft. Keep away from steering moving parts (nozzle, side vanes, linkage etc.).

Vacuum Bailer Pick-Ups

They are located each side of the drive shaft tunnel.

Two pick-ups use a low pressure area in the jet pump to siphon the water out of the bilge when the engine is operating.

Inspect each pick-up screen for obstructions, clean as necessary.

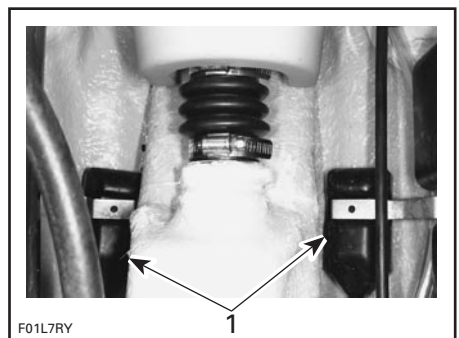

TYPICAL

1. Vacuum bailer pick-ups

Fuses

If an electrical problem occurs, check the fuses. If a fuse is burnt, replace by one of the same rating. Follow procedures below.

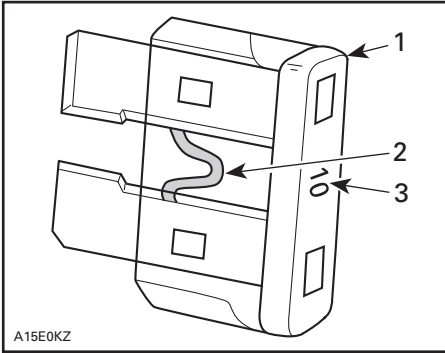

1. Fuse
2. Check if melted
3. Ampere rating

WARNING

Do not use a higher rated fuse as this can cause severe damage. If a fuse has burnt out, source of malfunction should be determined and corrected before restarting. See an authorized Sea-Doo dealer for servicing.

GTI Models

Fuses can be found on the MPEM. There are other fuses in the electrical box.

MPEM

To access fuses on the MPEM, remove seat.

Locate MPEM beside engine.

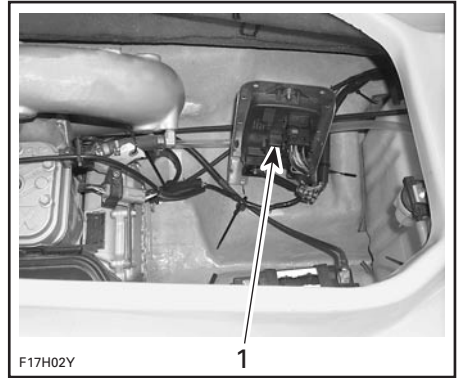

TYPICAL
1. MPEM

Fuses are identified, look beside the fuse holder. SPR means spare (fuse).

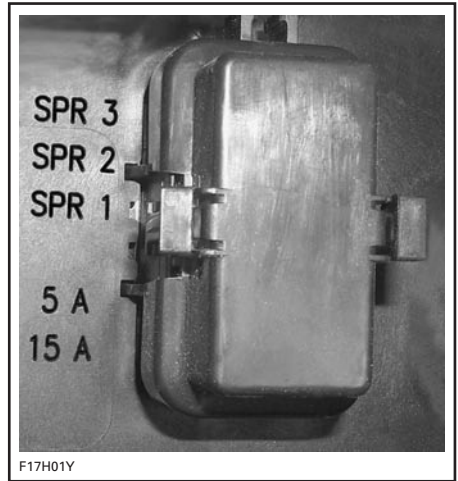

FUSE IDENTIFICATION
1. 5 A: MPEM
2. 15 A: Battery

Electrical Box

Remove darts retaining tubes then pull out both vent tubes each side of electrical box at rear of hull.

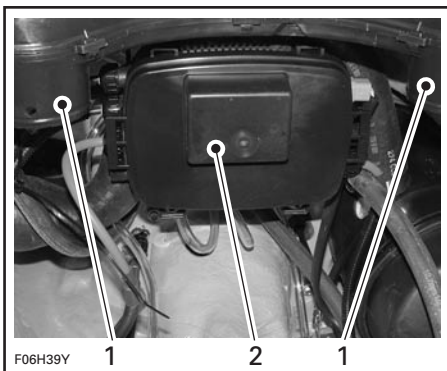

TYPICAL

1. Vent tubes removed
2. Electrical box

Unclip and remove cover of the electrical box to expose the holder of the main fuse.

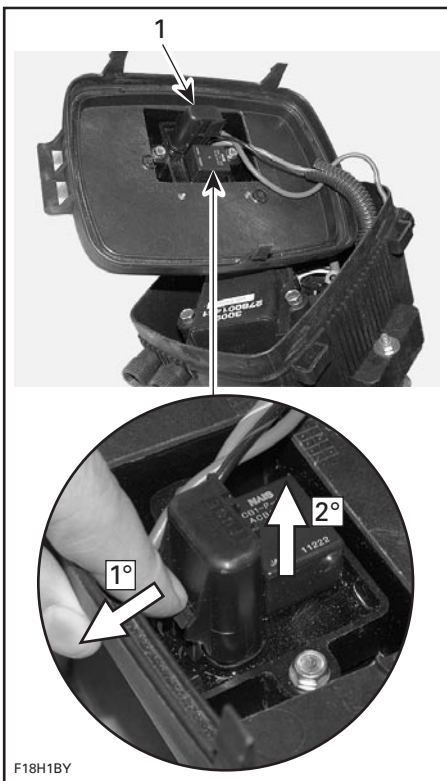

TYPICAL

1. Fuse holder

Properly reinstall removed components.

GTI RFI and GTI LE RFI Models

VCM

Locate VCM in front of engine.

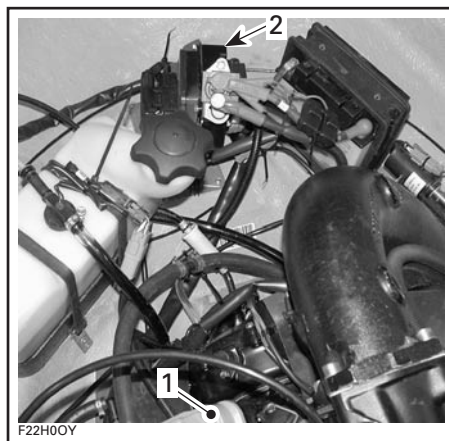

TYPICAL

1. Engine
2. VCM

Fuse are identified on the VCM. Look under the fuse holder.

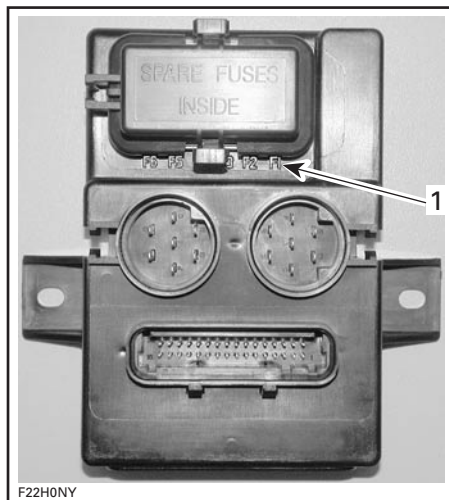

FUSE IDENTIFICATION

1. Fuse identification

FUSE IDENTIFICATION	FUSE CAPACITY AND FUNCTION
F1	5A, Accessories
F2	10A, Fuel pump
F3	5A, RAVE solenoid
F4	10A, Ignition coil and starter solenoid
F5	3A, Injector 1
F6	3A, Injector 2

Remove fuse cover from VCM.

Use the tabs of the fuse cover to remove and reinstall fuses.

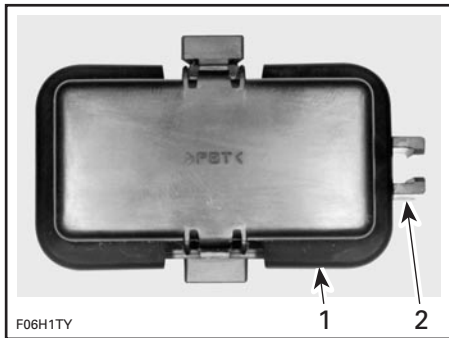

1. Fuse cover
2. Fuse tabs

Other Fuses

The main fuse and the charging system fuse are located beside the VCM.

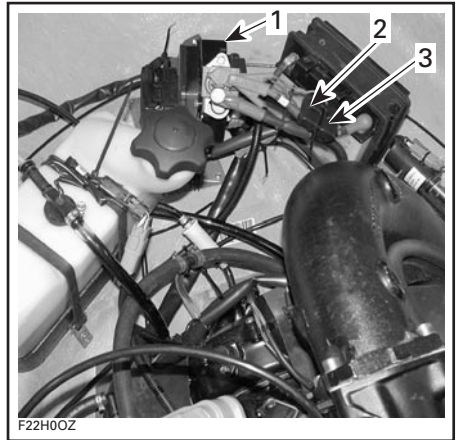

1. VCM
2. Main fuse
3. Charging system fuse

All Models

O.P.A.S. System

The O.P.A.S. system operation and condition should be checked by an authorized Sea-Doo dealer.

General Inspection and Cleaning

Inspection

Check engine compartment for any damage and fuel/oil injection systems for leaks. Ensure all hose clamps are properly secured and no hose is cracked, kinked or presenting any other damage.

WARNING

If any gasoline leak and/or odor are present, do not start the engine. Have the watercraft serviced by an authorized Sea-Doo dealer.

Inspect muffler, battery, fuel tank and oil reservoir fastening devices. Visually check electrical connections for corrosion and tightness.

Inspect hull and jet pump water intake grate for damage. Replace or have damaged parts repaired.

 **WARNING**

Periodically verify the seat lock pin and tighten if needed. Make sure seat securely latches.

Cleaning

The bilge should be cleaned by an authorized Sea-Doo dealer to remove any fuel/oil/electrolyte deposits and mildew.

Occasionally, wash the body with water and soap (only use mild detergent). Remove any marine organisms from engine and/or hull. Apply non-abrasive wax such as silicone wax.

CAUTION: Never clean fiberglass and plastic parts with strong detergent, degreasing agent, paint thinner, acetone, etc.

To clean the carpets, use 3M™ Citrus Base Cleaner (24 oz spay can) or the equivalent.

Stains may be removed from seat and fiberglass with Knight's Spray-Nine from Korkay System Ltd or the equivalent.

Respect the environment by ensuring fuel, oil or cleaning solutions do not drain into the waterways.

TRAILERING, STORAGE AND PRESEASON PREPARATION

Trailerling

CAUTION: To avoid damaging O.P.A.S. side vanes, the maximum trailer wood bunks span including trailer bunk width should not exceed 71 cm (28 in). Ends of both trailer wood bunks should not be more than 2.59 m (102 in) away from watercraft bow attachment point. See following illustration.

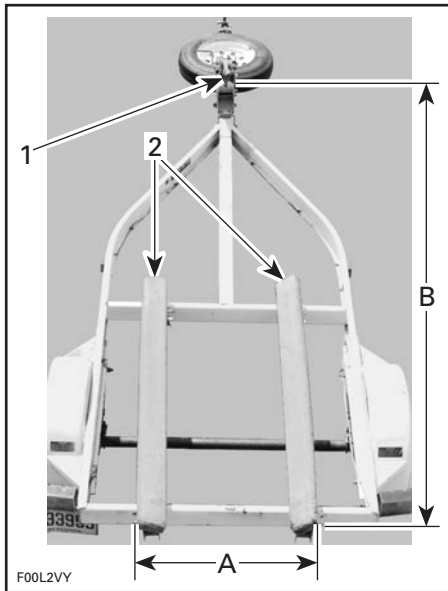

1. Watercraft bow attachment point
 2. Wood bunks
- A. 71 cm (28 in)
B. 2.59 m (102 in)

⚠ WARNING

Always turn the fuel tank valve (if so equipped) to OFF position when trailerling or docking the watercraft.

Make sure that oil reservoir and fuel tank caps are properly installed.

⚠ WARNING

Never tip this vehicle on end for transporting. We recommend that you carry the vehicle in its normal operating position.

Check the applicable laws and regulations in your area concerning towing a trailer, especially the following rules:

- brake system
- tow vehicle weight
- mirrors.

Take the following precautions when towing the watercraft:

Tie the watercraft to both bow and stern (front/rear) eyelets so that it is firmly retained on the trailer. Use additional tie-downs if necessary.

CAUTION: Do not route ropes or tie-downs over the seat as they could produce permanent damage. Wrap ropes or tie-downs with rags or similar protectors where they can touch the watercraft body.

Ensure all storage compartment covers and seat are properly latched.

⚠ WARNING

Make sure seat is securely latched before prior to trailerling.

A Sea-Doo cover can protect the watercraft, particularly before driving on dirt roads, to prevent dirt entry through the air intake opening(s).

Observe trailerling safety precautions.

Launching/Loading

CAUTION: Before launching the watercraft, ensure the bilge plugs are fully screwed. After loading the watercraft, ensure they are removed to drain bilge.

Storage

WARNING

Because fuel and oil are flammable, have an authorized Sea-Doo dealer inspect the fuel and oil systems integrity as specified in the periodic inspection chart.

It is recommended that the watercraft be serviced by an authorized Sea-Doo dealer for storage but the following operations can be performed by you with a minimum of tools.

CAUTION: Do not run the engine during the storage period.

Engine Draining

Check engine drain hose (lowest hose of engine). Make sure there is no sand or other particles in it and that it is not obstructed so that water can exit the engine. Clean hose and fitting as necessary.

CAUTION: Water in engine drain hose should be free to flow out, otherwise water could be trapped in engine. Should water freeze in engine, severe damage will occur. Check engine drain hose for obstructions.

Carburetor-Equipped Models

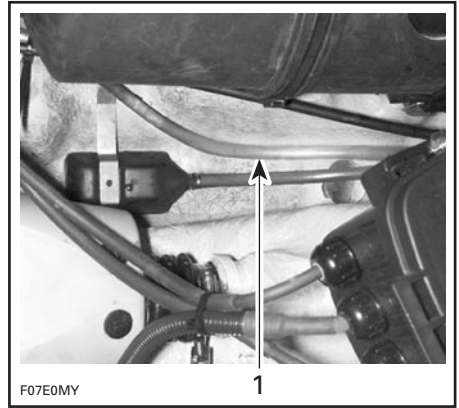

TYPICAL
1. Engine drain hose

RFI Models

Disconnect the water supply hose used to cool the magneto. It features a quick connect fitting. Press both tabs and pull fitting in order to disconnect hose.

This hose is located at the bottom of the magneto cover beside the engine support.

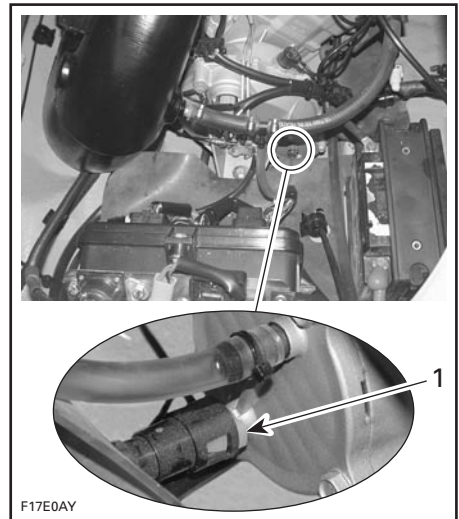

TYPICAL
1. Press tabs here and disconnect hose

Water should flow out of the fitting (magneto cooling circuit) and hose (crankcase heat exchanger). Push and hold hose against bilge so that draining can take place.

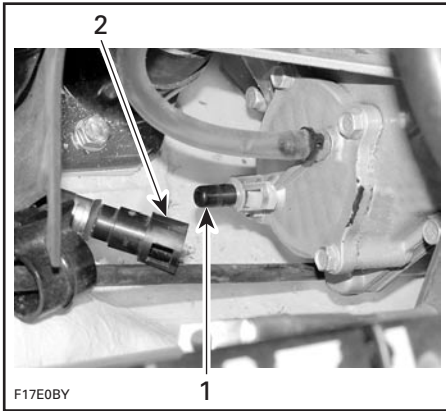

TYPICAL
1. Fitting
2. Hose

CAUTION: Water in heat exchanger system must be free to flow out. Should water freeze in engine, severe damage will occur.

Reconnect hose when done.

All Models

Lower hose, push and hold against bilge as necessary so that draining can take place.

Reconnect hose when done.

Body Rinsing/Repair

Wash the body with soap and water solution (only use mild detergent). Rinse thoroughly with fresh water. Remove marine organisms from the hull.

CAUTION: Never clean fiberglass and plastic parts with strong detergent, degreasing agent, paint thinner, acetone, etc.

For small gelcoat repairs, refer to an authorized Sea-Doo dealer. Replace damaged labels/decals.

Propulsion System

Lubricant in jet pump reservoir should be drained and reservoir cleaned. Refer to an authorized Sea-Doo dealer for this operation.

Grease lubrication point(s) of propulsion system as explained in MAINTENANCE section.

Fuel System

Sea-Doo fuel stabilizer (or equivalent), can be added in fuel tank to prevent fuel deterioration and carburetor gumming. Follow manufacturer's instructions for proper use.

CAUTION: Fuel stabilizer should be added prior to engine lubrication to ensure fuel system components protection against varnish deposits.

⚠ WARNING

Always stop the engine before refueling. Fuel is flammable and explosive under certain conditions. Always work in a well ventilated area. Do not smoke or allow open flames or sparks in the vicinity. Fuel tank may be pressurized, turn cap slowly when opening. Never use an open flame to check fuel level. When fueling, keep watercraft level. Do not overfill or top off the fuel tank and leave watercraft in the sun. As temperature increases, fuel expands and might overflow. Always wipe off any fuel spillage from the watercraft. Periodically verify fuel system. Always turn the fuel tank valve (if so equipped) to OFF position when the watercraft is not in use.

Cooling System Flushing and Engine Internal Lubrication

Refer to procedure in POST-OPERATION CARE.

Battery

Contact your authorized Sea-Doo dealer.

Antifreezing Protection

NOTE: This procedure requires approximately 2.5 L (2.6 U.S. qt.) of antifreeze.

In cool regions where freezing point may be encountered, cooling system should be filled with an equal part of water and antifreeze solution.

CAUTION: Antifreeze must be fed in cooling system. Otherwise remaining water will freeze. This operation requires a good technical knowledge of the cooling system path. If antifreezing is not performed adequately, any water left in the engine/exhaust system could freeze and cause severe damage. We strongly recommend this operation to be performed by an authorized Sea-Doo dealer.

CAUTION: Use only undiluted antifreeze (100% concentration). The pre-mixed antifreeze available from Bombardier Recreational Products Inc. is not suitable for this particular application. Its concentration will be reduced when mixed with remaining water trapped in water jackets. Always use ethylene glycol antifreeze containing corrosion inhibitors specifically recommended for aluminum engines. Never use antifreeze for RV (recreational vehicles).

NOTE: When available, it is recommended to use biodegradable antifreeze compatible with internal combustion aluminum engines. This will contribute to protect the environment.

NOTE: The engine will not have to run during this operation but should have been ran before, to exhaust as much water as possible, from cooling system components.

NOTE: It may be easier to reach hoses when you remove the vent tube support.

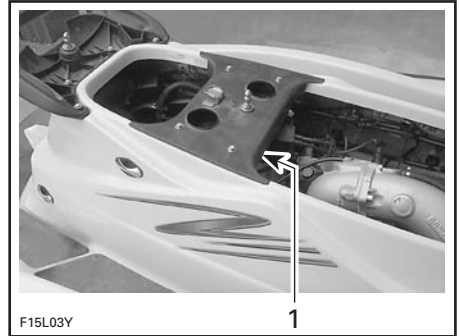

F15L03Y

1

TYPICAL

1. Vent tube support

Hose Pinchers Installation

Some hoses have to be plugged to prevent draining, before filling cooling system jackets with the antifreeze.

Install hose pinchers at the following location:

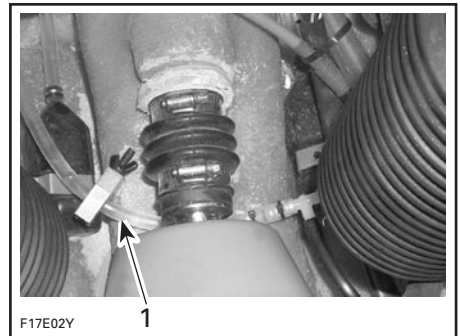

F17E02Y

1

GTI MODELS (717 ENGINES)

1. Engine drain hose

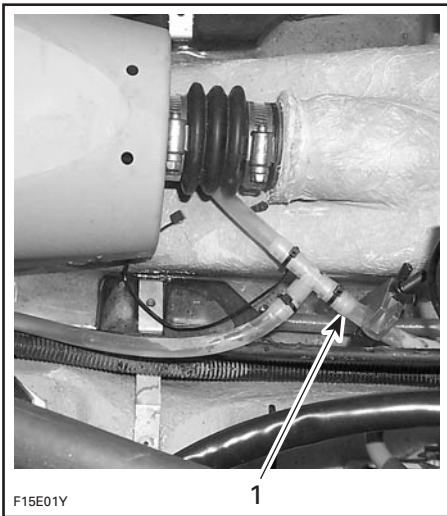

**GTI RFI AND GTI LE RFI MODELS
(787 RFI ENGINES)**
1. Engine drain hose

Make sure the fitting is properly connected to the magneto cover.

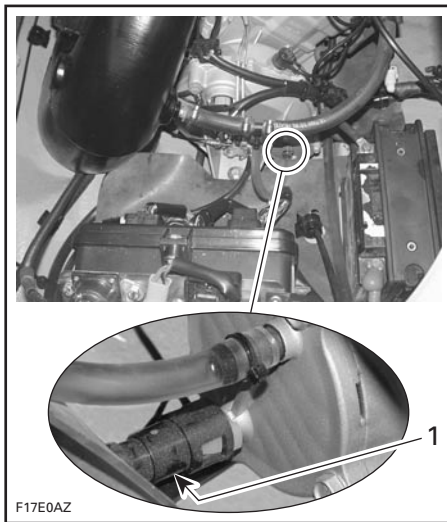

**GTI RFI AND GTI LE RFI MODELS
(787 RFI ENGINES)**
1. Fitting properly connected

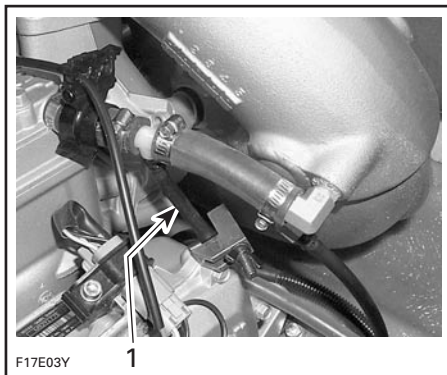

GTI MODELS (717 ENGINES)
1. Hose pincher on injection hose going to tuned pipe

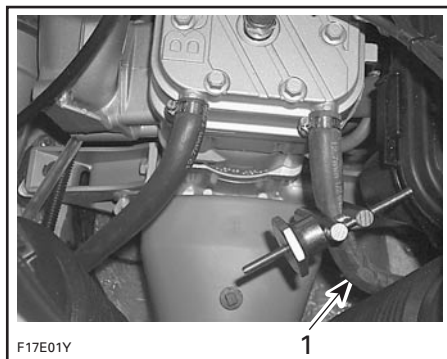

**TYPICAL — GTI, GTI RFI AND GTI LE RFI
MODELS (717 AND 787 RFI ENGINES)**
1. Engine water outlet hose

Hose Disconnection

Some hoses have to be disconnected. Disconnect hoses at the following location:

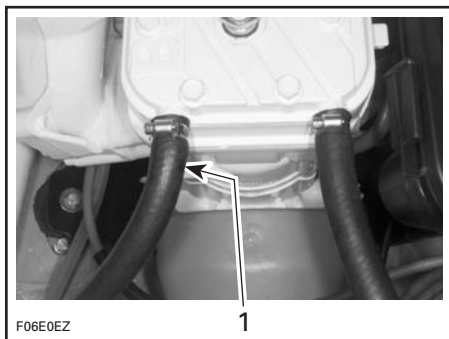

**GTI, GTI RFI AND GTI LE RFI MODELS
(717 AND 787 RFI ENGINES)**

1. Disconnect engine water inlet hose

Antifreeze

717 engines only: Temporarily install a short piece of hose to engine water inlet at cylinder head.

Insert a funnel into hose and pour antifreeze in engine until the colored solution appears at the cooling system bleed outlet.



787 RFI Engines

Disconnect hose just above T-fitting as shown.

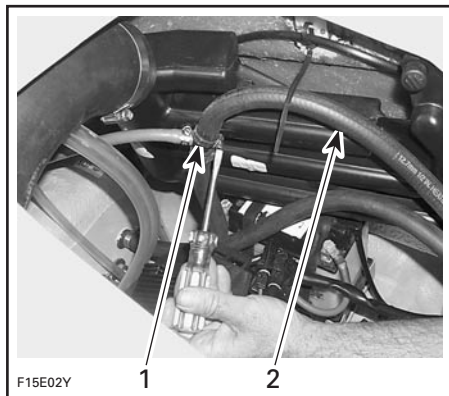

TYPICAL

1. Hose connecting to inlet fitting of cylinder head
2. Disconnect hose above T-fitting

Install a hose pincher just below T-fitting.

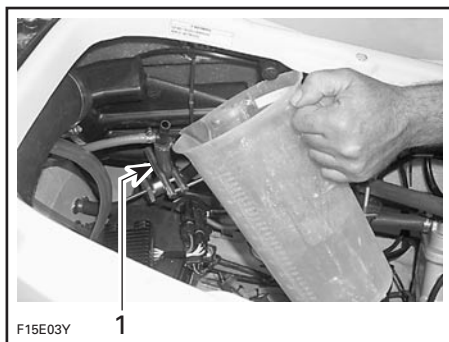

TYPICAL

1. Hose pincher below T-fitting

Pour approximately 300 mL (10 oz) of antifreeze in the water regulator valve supply hose to allow antifreeze flowing through the valve and into muffler to protect them.

Reconnect hose to T-fitting and remove hose pincher (if applicable).

Remove temporary hose (on 717 engines) and reconnect engine water outlet hose.

Remove remaining hose pinchers.

NOTE: Most of the antifreeze will drain out when removing the hose pinchers. Use a container to recover it. **DISPOSE ANTIFREEZE AS PER YOUR LOCAL LAWS AND REGULATIONS.**

NOTE: Although antifreeze mainly drained out, the antifreeze has mixed with the water that was possibly trapped in the water jackets. This will prevent freezing problems.

At preseason preparation, drain the remaining antifreeze from cooling system prior to using the watercraft.

The following steps should be performed to provide the watercraft enhanced protection.

Clean the bilge with hot water and detergent or with bilge cleaner. Rinse thoroughly. Lift front end of watercraft to completely drain bilge. If any repairs are needed to body or to the hull contact your authorized Sea-Doo dealer. For paint touch up to mechanical parts use BRP spray paint.

Reinstall vent tube support (if applicable).

Anticorrosion Treatment

Wipe off any residual water in the engine compartment.

Spray BOMBARDIER LUBE lubricant or equivalent over metallic components in engine compartment.

WARNING

Do not lubricate the safety lanyard post.

Lubricate the throttle cable with BOMBARDIER LUBE lubricant or equivalent.

Final Steps

Apply a good quality marine wax to the body.

The seat and the seat extension (if so equipped) should be partially left opened and storage baskets (if so equipped) should be removed during storage. This will prevent engine compartment condensation and possible corrosion.

If the watercraft is to be stored outside, cover it with an opaque tarpaulin to prevent sun rays and grime from affecting the plastic components, watercraft finish as well as preventing dust accumulation.

CAUTION: The watercraft should never be left in water for storage. Never leave the watercraft stored in direct sunlight. Never completely seal watercraft in a plastic wrap. Ventilation must be provided to avoid condensation and possible corrosion.

Preseason Preparation

Use the following chart.

Since technical skills and special tools are required, some operations should be performed by an authorized Sea-Doo dealer.

WARNING

Only perform procedures as detailed in this guide. It is recommended that the assistance of an authorized Sea-Doo dealer be periodically obtained on other components/ systems not covered in this guide. Unless otherwise specified, engine must not be running and the safety lanyard must be removed from its post for all maintenance procedures. Components inside engine compartment may be hot. When component conditions seem less than satisfactory, replace with genuine BRP parts or approved equivalents.

Preseason Preparation Chart

NOTE: It is highly recommended that an authorized Sea-Doo dealer perform the annual safety inspection and factory campaigns in addition to the preseason preparation all at the same time.

OPERATIONS		TO BE PERFORMED BY
GENERAL	Lubrication/corrosion protection	Operator
	Spark plug replacement ①	Dealer
ENGINE	Exhaust system condition (fasteners, hoses etc.)	Dealer
	RAVE valve cleaning (if so equipped)	Dealer
	Counterbalance shaft oil level (if so equipped)	Dealer
	TDC setting (RFI models)	Dealer
	Air compressor, visual condition of hoses. Check for leaks	Dealer
COOLING SYSTEM	Inspection of cooling system hoses and components	Dealer
FUEL SYSTEM	Throttle cable ② (and choke cable if so equipped) inspection/adjustment	Dealer
	Fuel filter replacement (carburetor-equipped models)	Dealer
	Fuel injection system sensors and throttle body verification (RFI models)	Dealer
	Fuel system; connections, check valves, lines, fasteners, pressurization ②	Dealer
	Filler neck, fuel tank and fuel cap condition ②	Dealer
	Fuel tank straps	Operator
	Refill fuel tank	Operator
LUBRICATION SYSTEM	Oil injection pump adjustment and bleeding	Dealer
	Oil filter replacement	Dealer
	Oil injection reservoir straps	Operator
	Oil injection reservoir filling	Operator
ELECTRICAL SYSTEM	Battery condition/charging and reinstallation	Dealer
	Battery, starter connections and routing ②	Dealer
	Monitoring beeper	Dealer
	Digitally encoded security system	Dealer
STEERING SYSTEM	Steering system adjustment/inspection ②	Dealer
O.P.A.S. SYSTEM	Check O.P.A.S. system condition	Dealer

OPERATIONS		TO BE PERFORMED BY
PROPULSION SYSTEM	Shifter system condition and cable adjustment	Dealer
	Propulsion system inspection	Dealer
	Jet pump oil replacement	Dealer
HULL AND BODY	Inspection of bailer pick-ups	Dealer

- ① Before installing new spark plugs, it is suggested to burn the excess BOMBARDIER LUBE lubricant or equivalent by starting the engine using the old spark plugs.
- ② Safety item covered in the annual safety inspection.

TROUBLESHOOTING

The following chart is provided to help in diagnosing the probable source of simple troubles. You may be able to solve many of these problems rather quickly, but others may require the skills of a mechanical technician. In such cases, consult an authorized Sea-Doo dealer for servicing.

Monitoring Beeper Coded Signals

CODED SIGNALS	POSSIBLE CAUSE	REMEDY
2 short beeps (while installing safety lanyard on post).	Confirms safety lanyard signal operation.	Engine can be started.
1 long beep (while installing safety lanyard on watercraft post).	Bad DESS system connection.	Reinstall safety lanyard cap correctly over post.
	Wrong safety lanyard.	Use a safety lanyard that has been programmed for the watercraft.
	Defective safety lanyard.	Use another programmed safety lanyard.
	Dried salt water in safety lanyard cap.	Clean safety lanyard cap to remove salt water.
	Defective DESS post.	Refer to an authorized Sea-Doo dealer.
Improper operation of ECM or defective wiring harness.		
A 2 seconds beep every 5 minutes intervals.	Fuel tank level is low or open circuit.	Refill. If problem persists, refer to an authorized Sea-Doo dealer.
A 2 seconds beep every 15 minutes intervals.	Water temperature sensor or circuit malfunction.	Refer to an authorized Sea-Doo dealer.
	Starter solenoid circuit malfunction.	Refer to an authorized Sea-Doo dealer.
4 short beeps every 3 seconds interval for 4 hours.	Safety lanyard has been left on its post without starting engine or after engine was stopped.	To prevent battery discharge, remove the safety lanyard from its post.
Continuously beeps.	Engine overheats.	See engine OVERHEATING.

Engine Will Not Start

OTHER OBSERVATION	POSSIBLE CAUSE	REMEDY
Engine does not turn over.	Safety lanyard removed.	Install cap over post.
	Burnt fuse: Carburetor-equipped models: On MPEM or in electrical box: battery, starting system RFI models: Starter solenoid on VCM or main fuse.	Check wiring then replace fuse(s).
	Discharged battery.	Refer to an authorized Sea-Doo dealer.
	Battery connections, corroded or loose.	Refer to an authorized Sea-Doo dealer.
	Water-flooded engine.	Refer to WATER-FLOODED ENGINE in SPECIAL PROCEDURES.
	Carburetor-equipped models: Faulty MPEM. RFI models: Faulty sensor, VCM or ECM.	Refer to an authorized Sea-Doo dealer.
	Seized engine.	Refer to an authorized Sea-Doo dealer.
	Seized jet pump.	Try to clean. Otherwise, refer to an authorized Sea-Doo dealer.
Engine turns slowly.	Loose battery cable connections.	Check/clean/tighten.
	Discharged or weak battery.	Refer to an authorized Sea-Doo dealer.
	Worn starter.	Refer to an authorized Sea-Doo dealer.

OTHER OBSERVATION	POSSIBLE CAUSE	REMEDY
Engine turns normally.	Closed fuel tank valve (carburetor-equipped models).	Turn fuel tank valve to ON position.
	Fuel tank empty or water-contaminated.	Refill. Siphon and fill with fresh fuel.
	Fuel filter clogged or water-contaminated (carburetor-equipped models).	Clean, check fuel tank for water.
	Fouled/defective spark plugs.	Replace.
	Misuse of choke (carburetor-equipped models).	Use only with cold engine. Replace spark plugs.
	Fuel-flooded engine.	Refer to FUEL-FLOODED ENGINE in SPECIAL PROCEDURES.
	Faulty component in the fuel injection system (RFI models).	Refer to an authorized Sea-Doo dealer.
	Burnt fuel pump fuse (RFI models).	Check wiring then replace fuse.
	Electrical problem (RFI models).	Refer to an authorized Sea-Doo dealer.

Engine Misfires, Runs Irregularly

OTHER OBSERVATION	POSSIBLE CAUSE	REMEDY
Weak spark.	Fouled/defective/worn spark plugs.	Replace.
	Carburetor-equipped models: Faulty MPEM. RFI models: Faulty ECM.	Refer to an authorized Sea-Doo dealer.
	Too much oil supplied to engine.	Improper oil pump adjustment, refer to an authorized Sea-Doo dealer.

OTHER OBSERVATION	POSSIBLE CAUSE	REMEDY
Lean fuel mixture.	Fuel: Level too low, stale or water-contaminated.	Siphon and/or refill.
	Fuel filter, clogged or water-contaminated (carburetor-equipped models).	Refer to an authorized Sea-Doo dealer.
	Fuel tank valve (carburetor-equipped models) partially open.	Turn fuel tank valve to ON position.
	Clogged injectors (RFI models).	Refer to an authorized Sea-Doo dealer.
	Defective sensor or MPEM (RFI models).	Refer to an authorized Sea-Doo dealer.
Rich fuel mixture (high fuel consumption).	Flame arrester dirty/clogged (if so equipped).	Clean or replace.
	Partially closed choke (carburetor-equipped models).	Refer to an authorized Sea-Doo dealer.
	Defective sensor or ECM (RFI models).	Refer to an authorized Sea-Doo dealer.

Engine Overheats

OTHER OBSERVATION	POSSIBLE CAUSE	REMEDY
Monitoring beeper sounds continuously.	Clogged jet pump water intake.	Clean.
	Clogged coolant system.	Flush cooling system.

Engine Continually Backfires

OTHER OBSERVATION	POSSIBLE CAUSE	REMEDY
Weak spark.	Fouled/defective/worn spark plugs.	Replace.
Overheated engine.	See engine OVERHEATS.	Refer to an authorized Sea-Doo dealer.
	Faulty rev limiter in MPEM (carburetor-equipped models).	Refer to an authorized Sea-Doo dealer.
	Spark plug leads or wiring reversed.	Connect spark plug cables at their proper location. Otherwise, refer to an authorized Sea-Doo dealer.

Engine Pinging or Knocking

OTHER OBSERVATION	POSSIBLE CAUSE	REMEDY
	Poor quality gasoline/low octane.	Use well known quality and recommended gasoline.
	Spark plug heat range too high.	Use recommended spark plugs.
	TDC setting.	Refer to an authorized Sea-Doo dealer.

Engine Lacks Acceleration or Power

OTHER OBSERVATION	POSSIBLE CAUSE	REMEDY
	Weak spark.	Refer to engine MISFIRES, RUNS IRREGULARLY.
	Incorrect fuel mixture (carburetor-equipped models).	Refer to engine MISFIRES, RUNS IRREGULARLY.
	Water in fuel or injection oil.	Siphon and replace.
Overheated engine.		See engine OVERHEATS.
	Clogged injectors (RFI models).	Refer to an authorized Sea-Doo dealer.
	Low fuel pressure (RFI models).	Refer to an authorized Sea-Doo dealer.
	Stuck RAVE valves (if so equipped).	Refer to an authorized Sea-Doo dealer.

Watercraft Can Not Reach Top Speed

OTHER OBSERVATION	POSSIBLE CAUSE	REMEDY
	Battery voltage is too low.	Refer to an authorized Sea-Doo dealer.
Cavitation.	Jet pump water intake clogged.	Clean.
	Damaged impeller.	Replace. Refer to an authorized Sea-Doo dealer.
	Damaged wear ring.	Replace. Refer to an authorized Sea-Doo dealer.

Abnormal Noise From Propulsion System

OTHER OBSERVATION	POSSIBLE CAUSE	REMEDY
Cavitation.	Weeds or debris jammed around impeller.	Clean and check for damage.
	Damaged impeller shaft or drive shaft.	Refer to an authorized Sea-Doo dealer.

SPECIFICATIONS

MODELS		GTI (105A, 105B)	GTI RFI, GTI LE RFI (125A, 125B, 135A, 135B)
ENGINE			
Engine type		Rotax® 717, 2-stroke	Rotax® 787 RFI, 2-stroke
Induction type		Rotary valve	
Exhaust system		Water cooled/water injected	Water cooled/water injected with regulator
Exhaust valve		N.A.	Rotax Adjustable Variable Exhaust (RAVE)
Lubrication	Type	Oil injection	
	Oil type	XP-S synthetic 2-stroke oil OR XP-S mineral injection oil (or equivalent)	XP-S synthetic 2-stroke oil
Number of cylinders		2	
Displacement		718.2 cm ³ (43.81 in ³)	781.6 cm ³ (47.7 in ³)
Rev limiter setting		7100 ± 50 RPM	7200 ± 50 RPM
COOLING SYSTEM			
Type		Water cooled, total loss type. Direct flow from propulsion unit	
ELECTRICAL SYSTEM			
Magneto generator output		160 W @ 6000 RPM	270 W @ 6000 RPM
Ignition system type		Digital CDI	Digital inductive type
Spark plug	Make and type	NGK, BR8ES	
	Gap	0.45 mm (.018 in)	
Starting system		Electric starter	
Battery		12 V, 19 A•h	
Fuses		Refer to MAINTENANCE.	

MODELS		GTI (105A, 105B)	GTI RFI, GTI LE RFI (125A, 125B, 135A, 135B)
FUEL SYSTEM			
Fuel	Type	Regular unleaded gasoline	
	Minimum octane number	Inside North America: 87 (R + M)/2 Outside North America: 91 RON	
Carburetor		BN 40i (diaphragm). Fuel accelerator pump. Quantity: 1	N.A.
Fuel injection		N.A.	Rotax Fuel Injection (semi direct), single throttle body (56 mm (2.21 in))
PROPULSION			
Propulsion system		Bombardier Formula pump	
Jet pump type		Axial flow, single stage	
Transmission		Direct drive	
Reverse system		Yes	
Jet pump oil type		Sea-Doo synthetic polyolester oil SAE 75W90 GL5	
Pivoting angle of direction (nozzle)		~ 20°	
Minimum required water level for jet pump		90 cm (3 ft) underneath the lowest rear portion of hull	
DIMENSIONS			
Number of passengers ①		3	
Overall length		307 cm (121 in)	
Overall width		120 cm (47 in)	
Overall height		104 cm (41 in)	
Weight		282 kg (6230 lb)	GTI RFI: 315 kg (695 lb) GTI LE RFI: 371 kg (700 lb)
Load limit (passengers + luggage)		243 kg (536 lb)	

MODELS		GTI (105A, 105B)	GTI RFI, GTI LE RFI (125A, 125B, 135A, 135B)
CAPACITIES			
Fuel tank		56.5 L (15 U.S. gal)	
Oil injection reservoir		6 L (1.6 U.S. gal)	
Impeller shaft reservoir	Capacity	100 mL (3.4 U.S. oz)	
	Oil level	Up to plug	

N.A.: Not applicable

① Refer to load limit

BRP reserves the right to make changes in design and specifications and/or to make additions to, or improvements in its products without imposing any obligation upon itself to install them on its products previously manufactured.

INTERNATIONAL SYSTEM METRIC INFORMATION

BASE UNITS			
DESCRIPTION		UNIT	SYMBOL
length		meter	m
mass		kilogram	kg
force		newton	N
liquid		liter	L
temperature		Celsius	°C
pressure		kilo pascal	kPa
torque		newton-meter	N•m
land velocity		kilometer per hour	km/h
navigation velocity		knot	kn

PREFIXES			
PREFIX	SYMBOL	MEANING	VALUE
kilo	k	one thousand	1000
centi	c	one hundredth of	0.01
milli	m	one thousandth of	0.001
micro	μ	one millionth of	0.000001

CONVERSION FACTORS			
TO CONVERT	TO		MULTIPLY BY (1)
in	mm		25.4
in	cm		2.54
in ²	cm ²		6.45
in ³	cm ³		16.39
ft	m		0.3
oz	g		28.35
lb	kg		0.45
lbf	N		4.4
lbf•in	N•m		0.11
lbf•ft	N•m		1.36
lbf•ft	lbf•in		12
PSI	kPa		6.89
imp. oz	U.S. oz		0.96
imp. oz	mL		28.41
imp. gal	U.S. gal		1.2
imp. gal	L		4.55
U.S. oz	mL		29.57
U.S. gal	L		3.79
MPH	km/h		1.61
Fahrenheit	Celsius		(°F - 32) ÷ 1.8
Celsius	Fahrenheit		(°C x 1.8) + 32
hp	kW75

F00A2YL

(1) To obtain the reverse sequence, divide by the given factor. Example: to convert millimeters to inches, divide by 25.4.

NOTE: Conversion factors are rounded off to 2 decimals for easier use.

ABBREVIATIONS USED IN THIS MANUAL

ABBREVIATION	DESCRIPTION
AC	Alternate current
API	American petroleum institute
CARB	California air resource board
DC	Direct current
DESS	Digitally encoded security system
ECM	Engine control module
ECU	Electronic control unit
EMS	Engine management system
E.I.N.	Engine identification number
EPA	Environmental protection agency
HP	Horse power
LCD	Liquid Crystal Display
LED	Light-emitting diode
MAG	Magneto
MPEM	Multi-purpose electronic module
MPH	Mile per hour
N.A.	Not applicable
O.P.A.S.	Off-power assisted steering
OPT	Optional
PFD	Personal flotation device
P/N	Part number
PTO	Power take off
STD	Standard
TBD	To be determined
TDC	Top dead center
TOPS	Tip-over protection system

WARRANTY

NORTH AMERICA

USA (Except Puerto Rico)	BRP US Inc. 7575 Bombardier Court Wausau, WI. 54401 Phone: (715) 848-4957 Fax: (715) 847-6879 www.brp.com
CANADA	BOMBARDIER RECREATIONAL PRODUCTS INC. 75 J.A. Bombardier Sherbrooke, QC J1L 1W3 Phone: (819) 566-3366 Fax: (819) 566-3062 www.brp.com

If your Sea-Doo watercraft requires warranty service, you should take it to any authorized Sea-Doo dealer. Be sure to bring your warranty registration card or other valid proof of the original date of purchase. If a question or problem arises regarding warranty, first contact the service manager or owner of the Sea-Doo dealership.

To find the nearest authorized Sea-Doo dealer, dial: 1 800 882-2900.

NOTE: If outside Canada or USA, consult your local authorized Sea-Doo distributor.

BRP NORTH AMERICA LIMITED WARRANTY: 2005 SEA-DOO® GTI, GTI RFI, GTI LE RFI PERSONAL WATERCRAFT

1. SCOPE

Bombardier Recreational Products Inc. ("BRP")* warrants its model-year 2005 Sea-Doo GTI, GTI RFI, GTI LE RFI personal watercraft from defects in material or workmanship for the period and under the conditions described below.

All genuine BRP parts and accessories, installed by an authorized BRP dealer (as hereinafter defined) at the time of delivery of the Sea-Doo personal watercraft, carry the same warranty as that of the personal watercraft.

Use of the product for racing or any other competitive activity, at any point, even by a prior owner, will render this warranty null and void.

2. WARRANTY COVERAGE DURATION

This warranty will be in effect from the date of delivery to the first retail consumer or the date the product is first put into use, whichever occurs first and for a period of:

- a) TWELVE (12) CONSECUTIVE MONTHS for private use owners, except that the emission related components providing input to emission control (see list below) are covered for TWENTY-FOUR (24) CONSECUTIVE MONTHS OR 200 HOURS OF ENGINE USE whichever occurs first.
- b) FOUR (4) CONSECUTIVE MONTHS for commercial use owners, except that the emission related components providing input to emission control (see list below) are covered for TWENTY-FOUR (24) CONSECUTIVE MONTHS OR 200 HOURS OF ENGINE USE whichever occurs first. A personal watercraft is used commercially when it is used in connection with generating income or any work or employment during any part of the warranty period. A personal watercraft is also used commercially when, at any point during the warranty period, it has commercial tags or is licensed for commercial use.

Emission Related Components:

Throttle Position Sensor (TPS)
Air Temperature Sensor (ATS)
Air Pressure Sensor (APS)

The repair or replacement of parts or the performance of service under this warranty does not extend the life of this warranty beyond its original expiration date.

For Sea-Doo personal watercraft produced for sale in California, that are originally sold in California to a California resident or subsequently warranty registered to a California resident, please also refer to the applicable California Emissions Control Warranty Statement.

3. CONDITIONS TO HAVE WARRANTY COVERAGE

This warranty coverage is available only on Sea-Doo personal watercraft purchased as new and unused by its first owner from a BRP dealer authorized to distribute Sea-Doo products in the country in which the sale occurred ("BRP dealer"), and then only after the BRP specified pre-delivery inspection process is completed and documented. Warranty coverage only becomes available upon proper registration of the product by an authorized BRP dealer. Moreover, this warranty coverage is only available if the personal watercraft is purchased in the country in which the purchaser resides. BRP will not honor this limited warranty to any private use owner or commercial use owner if the preceding conditions have not been met. Such limitations are necessary in order to allow BRP to preserve the safety of its products, consumers and the general public.

Routine maintenance outlined in the Operator's Guide must be timely performed in order to maintain warranty coverage. BRP reserves the right to make warranty coverage contingent upon proof of proper maintenance.

4. WHAT TO DO TO OBTAIN WARRANTY COVERAGE

The customer must notify an authorized servicing BRP dealer within two (2) days of the appearance of a defect, and provide it with reasonable access to the product and reasonable opportunity to repair it. The customer must also present to the authorized BRP dealer, proof of purchase of the product and must sign the repair/work order prior to the start of the repair in order to validate the warranty repair. All parts replaced under this limited warranty become the property of BRP.

5. WHAT BRP WILL DO

BRP's obligations under this warranty are limited to, at its sole discretion, repairing parts found defective under normal use, maintenance and service, or replacing such parts with new genuine BRP parts without charge for parts and labor, at any authorized BRP dealer.

BRP reserves the right to improve or modify products from time to time without assuming any obligation to modify products previously manufactured.

6. EXCLUSIONS

The following are not warranted under any circumstances:

- Normal wear and tear;
- Routine maintenance items, tune ups, adjustments;
- Damage caused by failure to provide proper maintenance and/or storage, as described in the Operator's Guide;
- Damage resulting from removal of parts, improper repairs, service, maintenance, modifications or use of parts not manufactured or approved by BRP or resulting from repairs done by a person that is not an authorized servicing BRP dealer;
- Damage caused by abuse, abnormal use, neglect, or operation of the product in a manner inconsistent with the recommended operation described in the Operator's Guide;
- Damage resulting from accident, submersion, fire, theft, vandalism or any act of God;
- Operation with fuels, oils or lubricants which are not suitable for use with the product (see the Operator's Guide);
- Water damages caused by water ingestion;
- Damages related to gel coat finish including but not limited to cosmetic gel coat finish, blisters or fiberglass delamination caused by blisters, crazing, spider of hairline cracks; and
- Incidental or consequential damages, or damages of any kind including without limitation towing, storage, telephone, rental, taxi, inconvenience, insurance coverage, loan payments, loss of time, loss of income.

7. LIMITATIONS OF LIABILITY

THIS WARRANTY IS EXPRESSLY GIVEN AND ACCEPTED IN LIEU OF ANY AND ALL OTHER WARRANTIES, EXPRESSED OR IMPLIED, INCLUDING WITHOUT LIMITATION ANY WARRANTY OF MERCHANTABILITY OR FITNESS FOR A PARTICULAR PURPOSE. TO THE EXTENT THAT THEY CANNOT BE DISCLAIMED, THE IMPLIED WARRANTIES ARE LIMITED IN DURATION TO THE LIFE OF THE EXPRESS WARRANTY. INCIDENTAL AND CONSEQUENTIAL DAMAGES ARE EXCLUDED FROM COVERAGE UNDER THIS WARRANTY. SOME STATES/PROVINCES DO NOT ALLOW FOR THE DISCLAIMERS, LIMITATIONS AND EXCLUSIONS IDENTIFIED ABOVE, AS A RESULT, THEY MAY NOT APPLY TO YOU. THIS WARRANTY GIVES YOU SPECIFIC RIGHTS, AND YOU MAY ALSO HAVE OTHER LEGAL RIGHTS WHICH MAY VARY FROM STATE TO STATE, OR PROVINCE TO PROVINCE.

Neither the distributor, any BRP dealer nor any other person has been authorized to make any affirmation, representation or warranty regarding the product, other than those contained in this limited warranty, and if made, shall not be enforceable against BRP. BRP reserves the right to modify this warranty at any time, being understood that such modification will not alter the warranty conditions applicable to the products sold while this warranty is in effect.

8. TRANSFER

If the ownership of a product is transferred during the warranty coverage period, this warranty shall also be transferred and be valid for the remaining coverage period provided that BRP is notified of such transfer of ownership in the following way:

- a) The former owner contacts BRP (at the phone number provided below) or an authorized BRP dealer and gives the coordinates of the new owner; or
- b) BRP or an authorized BRP dealer receives a proof that the former owner agreed to the transfer of ownership, in addition to the coordinates of the new owner.

9. CONSUMER ASSISTANCE

In the event of a controversy or a dispute in connection with this BRP limited warranty, BRP suggests that you try to resolve the issue at the dealership level. We recommend discussing the issue with the authorized dealer's service manager or owner.

If the issue has not yet been resolved, please submit your complaint in writing or call the appropriate number below:

IN CANADA:

BOMBARDIER RECREATIONAL
PRODUCTS INC.

CONSUMER SERVICES GROUP
VALCOURT QC J0E 2L0
TEL: (819) 566-3366

IN USA:

BRP US INC.

CONSUMER SERVICES GROUP
7575 BOMBARDIER COURT
WAUSAU WI 54401
TEL: (715) 848-4957

*In the USA, products are distributed and serviced by BRP US Inc.

©2004 Bombardier Recreational Products Inc. All rights reserved.

®Registered trademark and TM trademark of Bombardier Recreational Products Inc. or its affiliates.

CALIFORNIA EMISSION CONTROL WARRANTY STATEMENT FOR MODEL-YEAR 2005 SEA-DOO® GTI RFI, GTI LE RFI PERSONAL WATERCRAFT WITH RFI™ ENGINES.

Your Sea-Doo GTI RFI, GTI LE RFI personal watercraft may have a special environmental label required by the California Air Resources Board. The label has 1, 2, 3 or 4 stars. A hangtag, provided with your personal watercraft, describes the meaning of the star rating system.

The Star Label means Cleaner Marine Engines



F18L3CQ

The Symbol for Cleaner Marine Engines:

CLEANER AIR AND WATER

For a healthier lifestyle and environment.

Better Fuel Economy

Burns up to 30 - 40 percent less gas and oil than conventional carbureted two-stroke engines, saving money and resources.

Longer Emission Warranty

Protects consumer for worry free operation.

One Star - Low-Emission

The one-star label identifies personal watercraft, outboard, sterndrive and in-board engines that meet the Air Resources Board's Personal Watercraft and Outboard marine engine 2001 exhaust emission standards. Engines meeting these standards have 75% lower emissions than conventional carbureted two-stroke engines. These engines are equivalent to the U.S. EPA's 2006 standards for marine engines.

Two Stars - Very Low Emission

The two-star label identifies personal watercraft, outboard, sterndrive and in-board engines that meet the Air Resources Board's Personal Watercraft and Outboard marine engine 2004 exhaust emission standards. Engines meeting these standards have 20% lower emissions than One Star - Low-Emission engines.

Three Stars - Ultra Low Emission

The three-star label identifies engines that meet the Air Resources Board's Personal Watercraft and Outboard marine engine 2008 exhaust emission standards or the Sterndrive and Inboard marine engine 2003 exhaust emission standards. Engines meeting these standards have 65% lower emissions than One Star - Low Emission engines.

Four Stars - Super Ultra Low Emission

The four-star label identifies engines that meet the Air Resources Board's Sterndrive and Inboard marine engine 2009 exhaust emission standards. Personal Watercraft and Outboard marine engines may also comply with these standards. Engines meeting these standards have 90% lower emissions than One Star - Low Emission engines.

For more information:

Cleaner Watercraft – Get the Facts

1 800 END-SMOG

www.arb.ca.gov

YOUR EMISSION CONTROL WARRANTY RIGHTS AND OBLIGATIONS

The California Air Resources Board and BRP US Inc. ("BRP")* on behalf of Bombardier Recreational Products Inc. are pleased to explain the emission control system warranty on your model-year 2005 Sea-Doo GTI RFI, GTI LE RFI personal watercraft equipped with RFI engine. In California, new personal watercraft engines must be designed, built and equipped to meet the State's stringent anti-smog standards. BRP must warrant the emission control system on your personal watercraft engine for the periods of time listed below provided there has been no abuse, neglect or improper maintenance of your personal watercraft engine.

Your emission control system may include parts such as the carburetor or fuel injection system, the ignition system and catalytic converter. Also included may be hoses, belts, connectors and other emission-related assemblies.

Where a warrantable condition exists, BRP will repair your personal watercraft engine at no cost to you including diagnosis, parts and labor provided that such work is performed by an authorized BRP dealer.

Manufacturer's Limited Warranty Coverage

This emission warranty covers model year 2005 Sea-Doo GTI RFI, GTI LE RFI personal watercraft certified and produced by BRP for sale in California, that are originally sold in California to a California resident or subsequently warranty registered to a California resident. The BRP limited warranty conditions for Sea-Doo personal watercraft are still applicable to these models with the necessary modifications.

Select emission control parts of your 2005 Sea-Doo GTI RFI, GTI LE RFI personal watercraft are warranted from the date of delivery to the first retail consumer for a period of 4 years, or for 250 hours of use, whichever occurs first. However, warranty coverage based on the hourly period is only permitted for personal watercraft equipped with the appropriate hour meters or their equivalent. If any emission-related part on your engine is defective under warranty, the part will be repaired or replaced by BRP.

Parts Covered for 2005 Sea-Doo GTI RFI, GTI LE RFI Personal Watercraft Equipped with RFI Engines:

Fuel Rail	Fuel Lines	Water Temperature Sensor (WTS)
Rave Valve	Water Regulator	Fuel Pressure Regulator
Rotary Valve	Fuel Pump	Fuel Injectors
Tuned Pipe	Cylinder Head	Multi Purpose Electronic Module (MPEM)
High-Tension Ignition Wires	Throttle Position Sensor (TPS)	Electronic Control Module (ECU)
Electrical Harness	Ignition Coil	Exhaust Manifold
Throttle Body	Air Temperature Sensor (ATS)	Airbox and Flame Arrester
Exhaust Hoses	Air Pressure Sensor (APS)	All Emission Component Related Gaskets; Head, Base, Exhaust
Spark Plugs	Crankshaft Position Sensor (CPS)	

The emission warranty covers damage to other engine components that is caused by the failure of a warranted part.

The BRP Operator’s Guide provided contains written instructions for the proper maintenance and use of your personal watercraft. All emission warranty parts are warranted by BRP for the entire warranty period of the personal watercraft, unless the part is scheduled for replacement as required maintenance in the Operator’s Guide.

Emission warranty parts that are scheduled for replacement, as required maintenance, are warranted by BRP for the period of time before the first scheduled replacement date for that part. Emission warranty parts that are scheduled for regular inspection, but not regular replacement, are warranted by BRP for the entire warranty period of the personal watercraft. Any emission warranty part repaired or replaced under the terms of this warranty statement is warranted by BRP for the remainder of the warranty period of the original part. All parts replaced under this limited warranty become the property of BRP.

Maintenance receipts and records should be transferred to each subsequent owner of the personal watercraft.

Owner's Warranty Responsibilities

As the personal watercraft owner, you are responsible for the performance of the required maintenance listed in your Operator's Guide. BRP recommends that you retain all receipts covering maintenance on your personal watercraft engine, but BRP cannot deny warranty solely for the lack of receipts or your failure to ensure the performance of all scheduled maintenance.

As the personal watercraft owner, you should however be aware that BRP may deny you warranty coverage if your personal watercraft engine or a part has failed due to abuse, neglect, improper maintenance or unapproved modifications.

You are responsible for presenting your personal watercraft engine to an authorized BRP dealer as soon as a problem exists. The warranty repairs will be completed in a reasonable amount of time, not to exceed 30 days.

If you have any questions regarding your warranty rights and responsibilities or for the name and location of the nearest authorized BRP dealer you should contact the Customer Services Group at 1-715-848-4957.

* In the USA, products are distributed and serviced by BRP US Inc.

©2004 Bombardier Recreational Products Inc. All rights reserved.

®Registered trademark and ™ trademark of Bombardier Recreational Products Inc. or its affiliates.

BRP INTERNATIONAL LIMITED WARRANTY: 2005 SEA-DOO® GTI, GTI RFI, GTI LE RFI PERSONAL WATERCRAFT

1. SCOPE

Bombardier Recreational Products Inc. ("BRP") warrants its model-year 2005 Sea-Doo GTI, GTI RFI, GTI LE RFI personal watercraft from defects in material or workmanship for the period described below.

All genuine BRP parts and accessories, installed by an authorized BRP distributor/dealer (as hereinafter defined) at the time of delivery of the Sea-Doo personal watercraft, carry the same warranty as that of the personal watercraft.

Use of the product for racing or any other competitive activity, at any point, even by a prior owner will render this warranty null and void.

2. WARRANTY COVERAGE DURATION

This warranty will be in effect from the date of delivery to the first retail consumer or the date the product is first put into use, whichever occurs first and for a period of:

- a) TWELVE (12) CONSECUTIVE MONTHS, for private, recreational use.
- b) FOUR (4) CONSECUTIVE MONTHS, for commercial use. A personal watercraft is used commercially when it is used in connection with generating income or any work or employment during any part of the warranty period. A personal watercraft is also used commercially when, at any point during the warranty period, it has commercial tags or is licensed for commercial use.

The repair or replacement of parts or the performance of service under this warranty does not extend the life of this warranty beyond its original expiration date.

3. CONDITIONS TO HAVE WARRANTY COVERAGE

This warranty coverage is available only on Sea-Doo personal watercraft purchased as new and unused by its first owner from a BRP distributor/dealer authorized to distribute Sea-Doo products in the country in which the sale occurred ("BRP distributor/dealer"), and then only after the BRP specified pre-delivery inspection process is completed and documented.

Warranty coverage only becomes available upon proper registration of the product by a BRP distributor/dealer. Such limitations are necessary in order to allow BRP to preserve the safety of its products, consumers and the general public.

Routine maintenance outlined in the Operator's Guide must be timely performed in order to maintain warranty coverage. BRP reserves the right to make warranty coverage contingent upon proof of proper maintenance.

4. WHAT TO DO TO OBTAIN WARRANTY COVERAGE

The customer must notify a servicing BRP distributor/dealer within two (2) days of the appearance of a defect, and provide it with reasonable access to the product and reasonable opportunity to repair it. The customer must also present to the BRP distributor/dealer, proof of purchase of the product and must sign the repair/work order prior to the start of the repair in order to validate the warranty repair. All parts replaced under this limited warranty become the property of BRP.

5. WHAT BRP WILL DO

BRP's obligations under this warranty are limited to, at its sole discretion, repairing parts found defective under normal use, maintenance and service, or replacing such parts with new genuine BRP parts without charge for parts and labor, at any authorized BRP distributor/dealer.

BRP reserves the right to improve or modify products from time to time without assuming any obligation to modify products previously manufactured.

6. EXCLUSIONS

The following are not warranted under any circumstances:

- Normal wear and tear;
- Routine maintenance items, tune ups, adjustments;
- Damage caused by failure to provide proper maintenance and/or storage, as described in the Operator's Guide;
- Damage resulting from removal of parts, improper repairs, service, maintenance, modifications or use of parts not manufactured or approved by BRP or resulting from repairs done by a person that is not an authorized servicing BRP distributor/dealer;
- Damage caused by abuse, abnormal use, neglect or operation of the product in a manner inconsistent with the recommended operation described in the Operator's Guide;
- Damage resulting from accident, submersion, fire, theft, vandalism or any act of God;
- Operation with fuels, oils or lubricants which are not suitable for use with the product (see the Operator's Guide);
- Water damages caused by water ingestion;
- Damages related to gel coat finish including but not limited to cosmetic gel coat finish, blisters or fiberglass delamination caused by blisters, crazing, spider or hairline cracks; and
- Incidental or consequential damages, or damages of any kind including without limitation towing, storage, telephone, rental, taxi, inconvenience, insurance coverage, loan payments, loss of time, loss of income.

7. LIMITATIONS OF LIABILITY

THIS WARRANTY IS EXPRESSLY GIVEN AND ACCEPTED IN LIEU OF ANY AND ALL OTHER WARRANTIES, EXPRESSED OR IMPLIED, INCLUDING WITHOUT LIMITATION ANY WARRANTY OF MERCHANTABILITY OR FITNESS FOR A PARTICULAR PURPOSE. TO THE EXTENT THAT THEY CANNOT BE DISCLAIMED, THE IMPLIED WARRANTIES ARE LIMITED IN DURATION TO THE LIFE OF THE EXPRESS WARRANTY. INCIDENTAL AND CONSEQUENTIAL DAMAGES ARE EXCLUDED FROM COVERAGE UNDER THIS WARRANTY. SOME JURISDICTIONS DO NOT ALLOW FOR THE DISCLAIMERS, LIMITATIONS AND EXCLUSIONS IDENTIFIED ABOVE, AS A RESULT, THEY MAY NOT APPLY TO YOU. THIS WARRANTY GIVES YOU SPECIFIC RIGHTS, AND YOU MAY ALSO HAVE OTHER LEGAL RIGHTS WHICH MAY VARY FROM COUNTRY TO COUNTRY.

Neither the BRP distributor nor any other person has been authorized to make any affirmation, representation or warranty regarding the product, other than those contained in this limited warranty, and if made, shall not be enforceable against BRP.

BRP reserves the right to modify this warranty at any time, being understood that such modification will not alter the warranty conditions applicable to the products sold while this warranty is in effect.

8. TRANSFER

If the ownership of a product is transferred during the warranty coverage period, this warranty shall also be transferred and be valid for the remaining coverage period provided BRP is notified of such transfer of ownership in the following way:

BRP or an authorized BRP distributor/dealer receives a proof that the former owner agreed to the transfer of ownership, in addition to the coordinates of the new owner. The distributor will then forward this information directly to BRP.

9. CONSUMER ASSISTANCE

- a) In the event of a controversy or a dispute in connection with this BRP limited warranty, BRP suggests that you try to resolve the issue at the dealership level. We recommend discussing the issue with the authorized dealer's service manager or owner.
- b) If further assistance is required, the distributor's service department should be contacted in order to resolve the matter.
- c) If the matter still remains unresolved then contact BRP at the address listed below.

BOMBARDIER RECREATIONAL PRODUCTS INC.

CUSTOMER SERVICES GROUP
VALCOURT QC J0E 2L0
Tel.: 1 (819) 566-3366

© 2004 Bombardier Recreational Products Inc. All rights reserved.

® Registered trademark and ™ trademark of Bombardier Recreational Products Inc. or its affiliates.

PRIVACY INFORMATION

We wish to inform you that your coordinates will be used for safety and warranty purposes. Sometimes, we also use the coordinates of our clients to inform them about our products and to present them offers. Should you prefer not to receive information on our products, services and offers, please let us know by writing to the address below.

Also note that, from time to time, carefully selected and trustworthy organizations may be permitted to use the coordinates of our clients to promote quality products and services. If you prefer not to have your name and address released, please let us know by writing to the address below:

Bombardier Recreational Products Inc.
Warranty Department
75 J.A. Bombardier Street
Sherbrooke, Québec
J1L 1W3 Canada
Fax Number (819) 566-3590

AFFIX
PROPER
POSTAGE

**Bombardier
Recreational Products Inc.**

WARRANTY DEPARTMENT
75, J.A. Bombardier
Sherbrooke, QC
Canada
J1L 1W3

V00A2G

AFFIX
PROPER
POSTAGE

**Bombardier
Recreational Products Inc.**

WARRANTY DEPARTMENT
75, J.A. Bombardier
Sherbrooke, QC
Canada
J1L 1W3

V00A2G

WATERCRAFT MODEL No. _____

HULL IDENTIFICATION NUMBER (H.I.N.) _____

ENGINE IDENTIFICATION NUMBER (E.I.N.) _____

Owner: _____
NAME

No. STREET APT

CITY STATE/PROVINCE ZIP/POSTAL CODE

Purchase Date _____
YEAR MONTH DAY

Warranty Expiry Date _____
YEAR MONTH DAY

To be completed by the authorized Sea-Doo dealer at the time of the sale.

DEALER IMPRINT AREA

F00A30L

Please verify with your selling dealer to ensure your SEA-DOO watercraft has been registered with BRP.



219 000 367

CA

OPERATOR'S GUIDE, GTI / ENGLISH
GUIDE DU CONDUCTEUR, GTI / ANGLAIS

FAIT AU / MADE IN CANADA

U/M.P.C.

©™ TRADEMARKS OF BOMBARDIER RECREATIONAL PRODUCTS INC. OR ITS AFFILIATES.

*TRADEMARK OF BOMBARDIER INC. USED UNDER LICENSE.

†TRADEMARK OF CASTROL LIMITED USED UNDER LICENSE.

©2004 BOMBARDIER RECREATIONAL PRODUCTS INC. ALL RIGHTS RESERVED. PRINTED IN CANADA.

www.SeaDooManuals.net